

INSTRUCTION MANUAL

7A16 AMPLIFIER

Tektronix, Inc.

S.W. Millikan Way • P. O. Box 500 • Beaverton, Oregon 97005 • Phone 644-0161 • Cables: Tektronix
070-0980-00

1069



WARRANTY

All Tektronix instruments are warranted against defective materials and workmanship for one year. Tektronix transformers, manufactured in our plant, are warranted for the life of the instrument.

Any questions with respect to the warranty mentioned above should be taken up with your Tektronix Field Engineer.

Tektronix repair and replacement-part service is geared directly to the field, therefore all requests for repairs and replacement parts should be directed to the Tektronix Field Office or representative in your area. This procedure will assure you the fastest possible service. Please include the instrument Type and Serial or Model Number with all requests for parts or service.

Specifications and price change privileges reserved.

Copyright © 1969 by Tektronix, Inc., Beaverton, Oregon. Printed in the United States of America. All rights reserved. Contents of this publication may not be reproduced in any form without permission of the copyright owner.

TABLE OF CONTENTS

SECTION 1 SPECIFICATION	Page	SECTION 5 PERFORMANCE CHECK/ CALIBRATION	
Introduction	1-1	Introduction	5-1
Electrical Characteristics		Test Equipment Required	5-1
Deflection Factor	1-1	Short Form Procedure	5-2
Gain	1-1	Performance Check/Calibration Procedure	
Frequency Response	1-1	Preliminary Procedure	5-3
Maximum Input Voltage	1-1	Preliminary Control Settings	5-4
Input Resistance	1-1	Check or Adjust	
Input Capacitance	1-1	DC Balance	5-4
Maximum Input Gate Current	1-1	Variable Balance	5-4
Noise (Tangentially Measured)	1-1	STEP ATTENUATOR Range	5-4
DC Drift	1-1	STEP ATTENUATOR Balance	5-4
Environmental Characteristics		Position Centering	5-5
Altitude	1-1	POSITION Range	5-5
Transportation	1-1	+ UP to INVERT Shift	5-5
Physical Characteristics		GAIN	5-5
Finish	1-1	VARIABLE Range	5-6
Dimensions	1-1	Trigger DC Level	5-6
Weight	1-1	Trigger Gain	5-6
SECTION 2 OPERATING INSTRUCTIONS		VOLTS/DIV Deflection Accuracy	5-6
General	2-1	Input Compensation	5-7
Front Panel Controls and Connector	2-1	Series and Shunt Compensation	5-7
First Time Operation	2-1	High Frequency Compensation (5 mV)	5-8
Control Setup Chart	2-3	High Frequency Compensation (10 mV)	5-8
General Operating Information	2-3	High Frequency Compensation (20 mV)	5-8
Basic Applications	2-5	Step Response	5-9
SECTION 3 CIRCUIT DESCRIPTION		Upper -3 dB Point	5-9
Introduction	3-1	Trigger Step Response	5-10
Block Diagram Description	3-1	20 Megahertz Bandwidth Limiting	5-11
Detailed Circuit Description		Noise (Tangentially Measured)	5-11
Input Coupling	3-2	SECTION 6 ELECTRICAL PARTS LIST	
Input Attenuator	3-2	Abbreviations and Symbols	
Input Stage	3-2	Parts Ordering Information	
First Cascode Stage	3-2	Index of Electrical Parts List	
Second Cascode Stage	3-3	SECTION 7 DIAGRAMS AND MECHANICAL PARTS ILLUSTRATIONS	
Output Stage	3-3	Diagrams	
Readout Block	3-3	Mechanical Parts Illustrations	
SECTION 4 MAINTENANCE		SECTION 8 MECHANICAL PARTS LIST	
Preventive Maintenance		Mechanical Parts List Information	
Cleaning	4-1	Index of Mechanical Parts Illustrations	
Lubrication	4-1	Mechanical Parts List	
Visual Inspection	4-1	Accessories	
Transistor Checks	4-1	Change Information	
Recalibration	4-1	Abbreviations and symbols used in this manual are based on or taken directly from IEEE Standard 260 "Standard Symbols for Units", MIL STD-12B and other standards of the electronics industry. Change information if any, is located at the rear of this manual.	
Troubleshooting			
Troubleshooting Aids	4-2		
Troubleshooting Equipment	4-4		
Troubleshooting Techniques	4-4		
Corrective Maintenance			
Obtaining Replacement Parts	4-6		
Soldering Techniques	4-6		
Component Replacement	4-6		

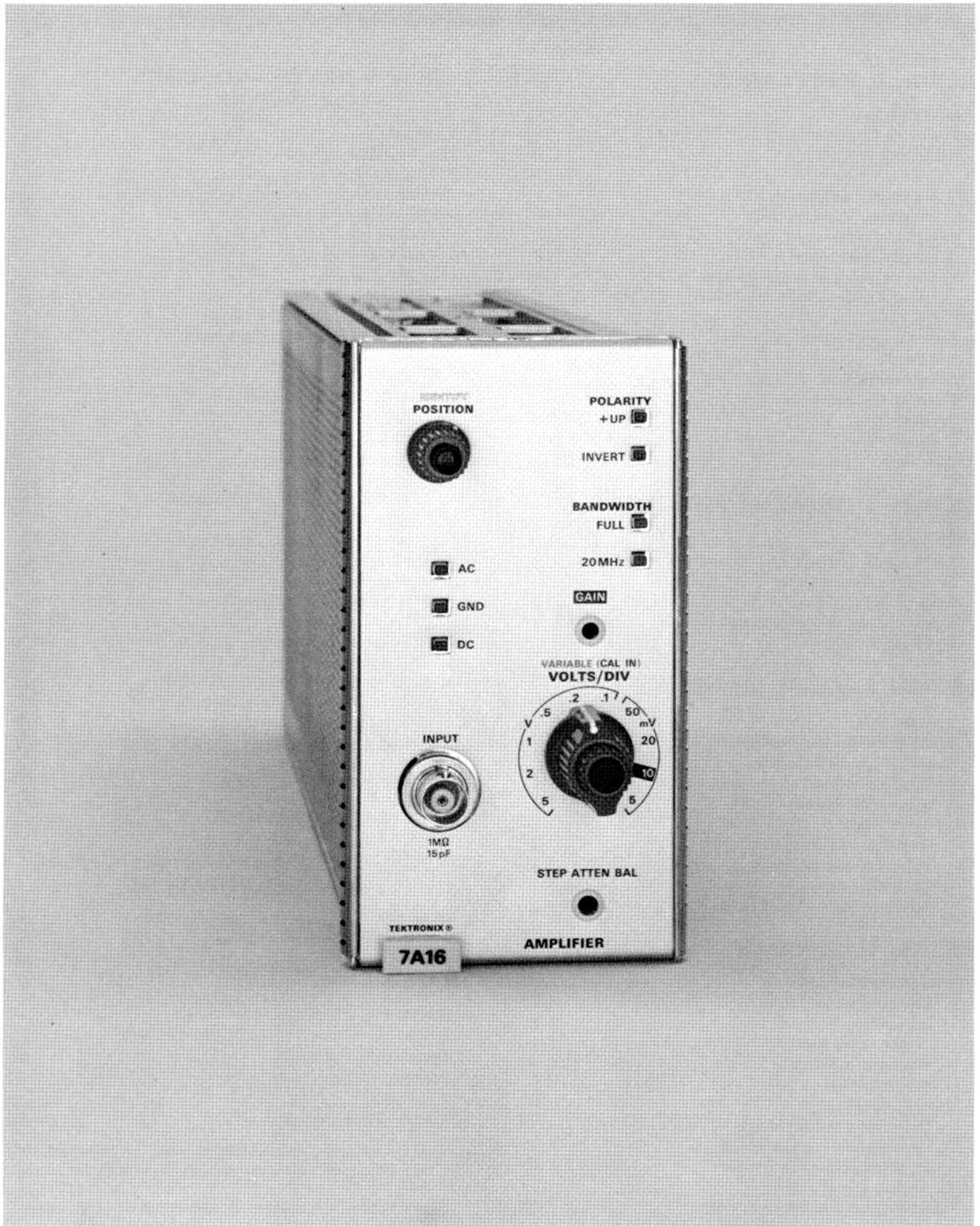

Fig. 1-1. Type 7A16 Amplifier.

SECTION 1

SPECIFICATIONS

Change information, if any, affecting this section will be found at the rear of the manual.

INTRODUCTION

The Type 7A16 vertical amplifier plug-in unit is part of the 7000-series oscilloscope system. It is a wide band DC coupled amplifier with calibrated deflection factors from 5 mV/Div to 5 V/Div. Internal gain and compensation circuits are automatically switched to correspond with the setting of the VOLTS/DIV switch. A polarity switch provides an inversion of the signal within the amplifier. A bandwidth limit switch allows low-frequency, low-level signals to be viewed with reduced interference from signals above 20 megahertz.

The upper bandwidth limit of the Type 7A16 is mainly determined by the oscilloscope in which it is used. For example, the Type 7A16 used with the Type 7504 oscilloscope will have an upper bandwidth limit of approximately 90 MHz, and when plugged into a Type 7704 oscilloscope the upper bandwidth limit will be approximately 150 MHz. Refer to the appropriate oscilloscope manual for complete information.

This instrument will meet the electrical characteristics listed in Table 1-1 following complete calibration as given in Section 5. The performance check procedure given in Section 5 provides a convenient method to check instrument performance without making internal adjustments.

The following electrical characteristics are valid over the stated environmental range for instruments calibrated at an ambient temperature of +20°C to +30°C, and after a five minute warmup unless otherwise stated.

The Type 7A16 should be calibrated every 1000 hours or every 6 months if used infrequently.

TABLE 1-1
ELECTRICAL

Characteristic	Performance	
Deflection Factor Calibrated Range	5 mV/Div to 5 V/Div, 10 steps in a 1-2-5 sequence.	
Gain Ratio Accuracy	Within 2% of gain adjusted at 10 mV/Div.	
Uncalibrated (Variable)	Continuously variable between calibrated deflection factor settings. Extends uncalibrated deflection factor to at least 12.5 V/Div.	
Gain	Permits adjustment of deflection factor for all 7000 series oscilloscopes.	
Frequency Response; System Dependent (8 division reference)	With Type 7704 Oscilloscope	With Type 7504 Oscilloscope
Upper Bandwidth DC Coupled	150 MHz	90 MHz
Lower Bandwidth AC Coupled	10 Hertz or less.	
With P6053 Probe	1 Hertz or less.	

20 Megahertz Bandwidth	DC to 20 megahertz within 3 megahertz.
Risetime	15 nanoseconds to 21 nanoseconds.
Maximum Input Voltage DC (Direct) Coupled	500 VDC. 500 V, DC + P-P AC at 1 kHz or less.
100 mV/Div to 5 V/Div	
5 mV/Div to 50 mV/Div	100 VDC. 100 V, DC + P-P AC at 1 kHz or less.
AC (Capacitance Coupled Input DC Voltage	500 V.
Input Resistance	1 megohm within 2%.
Input Capacitance	15 picofarads within 0.5 picofarad.
R and C Product	Within 1% over all deflection factor settings.
Maximum Input Gate Current	0.5 nanoampere or less at 0°C to +35°C, 3 nanoamperes or less at +35°C to +50°C.
Displayed Noise (Tangentially Measured)	0.1 division or less at 5 mV measured in a 7700-Series Oscilloscope.
DC Drift	250 μ V/minute (P-P) or 0.05 division (whichever is greater) after 1 hour warmup.
Drift With Time (Ambient Temperature and Line Voltage Constant) Short Term	
Long Term	250 μ V/hour (P-P) of 0.05 division (whichever is greater) after 1 hour warmup.
Drift With Ambient Temperature (Line Voltage Constant)	100 μ V/°C or less.

TABLE 1-2
ENVIRONMENTAL

Characteristic	Performance
Temperature Operating	0°C to +50°C
Altitude Non-operating	To 50,000 feet and -55°C
Transportation	Qualified under National Safe Transit Committee test procedure 1A, Category II.

TABLE 1-3
PHYSICAL

Item	Information
Finish	Front Panel is anodized aluminum.
Weight	About 1.75 pounds.
Dimensions	Fits plug-in compartment of 7000-Series Oscilloscopes.

SECTION 2

OPERATING INSTRUCTIONS

Change information, if any, affecting this section will be found at the rear of the manual.

General

The Type 7A16 vertical plug-in unit operates with a Tektronix 7000-series oscilloscope and a 7B-series time base unit to form a complete oscilloscope system. To effectively use the Type 7A16, the operation and capabilities of the instrument should be known. This section describes the operation of the front-panel controls and connector, gives first time operation and general operating information, and lists some measurement techniques using the amplifier.

Installation

The Type 7A16 is designed to operate in a vertical plug-in compartment of Tektronix 7000-series oscilloscopes. For X-Y operation, the plug-in unit may also be installed in a horizontal plug-in compartment. (Refer to the indicator oscilloscope instruction manual for information concerning X-Y operation.)

To install the Type 7A16 into a plug-in compartment, push it in until it is seated into the front panel of the indicator unit. Pull the release latch to disengage the plug-in unit, then continue pulling on the release latch to remove the plug-in from the indicator.

FRONT PANEL CONTROLS AND CONNECTOR

All controls required for operation of the Type 7A16 are located on the front panel of the unit. A brief description of the function or operation of the front-panel controls follows. More detailed information is given under General Operating Information.

VOLTS/DIV	Selects vertical deflection factor from 5 mV/DIV to 5 V/DIV in 1-2-5 sequence (VAR control must be in the calibrated position for indicated deflection factor).
VARIABLE (CAL IN)	Provides variable uncalibrated deflection factors to at least 2.5 times the setting of the VOLTS/DIV switch. Push knob in and release to activate; the knob moves outward from the VOLTS/DIV control when activated.
POSITION	Controls vertical position of trace.
IDENTIFY	Moves trace upward about 0.25 division for identification. (Also replaces readout information with the word IDENTIFY.)

POLARITY	Provides means of inverting the display. +UP: A positive-going voltage at the INPUT produces a positive deflection on the CRT. INVERT: A positive-going voltage at the INPUT produces a negative deflection on the CRT.
BANDWIDTH	Provides limiting of upper bandwidth. FULL: Normal operation with full bandwidth capabilities. 20 MHz: Amplifier bandwidth limited to 20 MHz to provide a reduction in displayed high-frequency noise or interference.
AC-GND-DC	Selects method of coupling input signal to Input Amplifier.
GAIN	Screwdriver adjustment to set gain of the amplifier. Gain standardized at 10 mV/Div.
STEP ATTEN BAL	Screwdriver adjustment to minimize trace shift when switching VOLTS/DIV control.
INPUT	Signal input connector. Input impedance of 1 megohm paralleled by 15 picofarads. Similar to standard BNC connector, but with additional conductor to indicate to the readout circuit the attenuation factor of the probe being used.

FIRST-TIME OPERATION

General

When shipped from the factory, the Type 7A16 has been calibrated to meet the specifications listed in Section 1 and is ready to be used with an indicator oscilloscope.

The following steps demonstrate the basic operation of the controls of the Type 7A16. It is recommended that this procedure be followed completely for familiarization with the instrument. Operation of the indicator oscilloscope and time base unit is described in the instruction manuals for these units.

Setup Information

1. Insert the Type 7A16 into a vertical plug-in compartment of a 7000-series indicator oscilloscope.
2. Insert a 7B-series time-base unit into a horizontal plug-in compartment.
3. Set the controls as follows:

Operating Instructions—Type 7A16

Type 7A16

VOLTS/DIV	10 mV
VARIABLE (CAL IN)	Calibrated
POSITION	Midrange
POLARITY	+UP
BANDWIDTH	FULL
AC-GND-DC	GND

Time Base

Time/Div	0.5 ms
Variable Time/Div	Calibrated
Slope	0/+
MODE	P-P Auto
Coupling	AC
Source	Int
Position	Midrange

Indicator Oscilloscope

Calibrator	40 mV Square Wave
Intensity	Counterclockwise
Focus	Midrange
Astigmatism	Midrange
Scale Illum	As desired

4. Connect the oscilloscope to a power source which meets the voltage and frequency requirements of the oscilloscope power supply.

5. Turn the oscilloscope power on and allow about five minutes warmup time.

6. Advance the Intensity and set the time base unit triggering controls to obtain a free-running trace on the CRT. Adjust the POSITION controls to center the trace vertically.

7. Connect the Calibrator output to the INPUT connector, using a 50-ohm BNC cable. Push the Type 7A16 DC input coupling button. (Adjust horizontal and vertical POSITION controls as necessary.)

8. Set the triggering controls for a stable display. (Adjust Focus and Astigmatism controls as necessary.)

9. Check the display for four divisions of vertical deflection (see Fig. 2-1). If necessary, adjust the front panel GAIN control for four divisions of deflection.

10. Press the IDENTIFY button to erase the readout information. When the IDENTIFY button is pressed and released, the display moves up and down about 0.25 division. This movement identifies the waveform when more than one display is on the CRT.

11. Press the INVERT button to display the opposite polarity of the square wave. (When observing a symmetrical waveform such as the Calibrator square wave, inverting the signal makes no apparent change in the display. This is because the time-base unit triggers on the indicated slope of the displayed waveform.)

12. Switch the VOLTS/DIV control through the remaining positions of the switch, setting the Calibrator to appropriate output amplitudes. The STEP ATTEN BAL control may be adjusted to minimize trace shift when switching the VOLTS/DIV control from 5 mV/DIV to 20 mV/DIV.

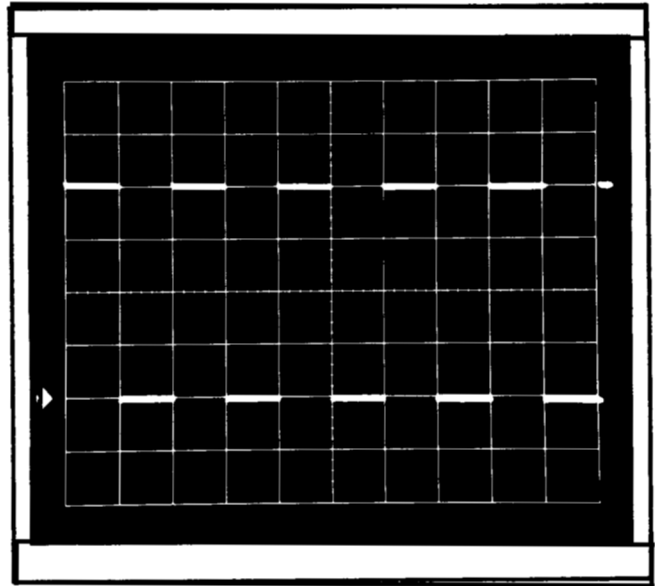

Fig. 2-1. 40 mV Calibrator square wave.

This completes the basic operating procedure for the Type 7A16. Instrument operations not explained here, or operations which need further explanation, are discussed under General Operating Information.

CONTROL SETUP CHART

Figure 2-2 shows the front panel of the Type 7A16. This chart can be reproduced and used as a front-panel record for special measurements, applications or procedures, or it may be used as a training aid for familiarization with this instrument.

GENERAL OPERATING INFORMATION

Signal Connection

In general, probes offer the most convenient means of connecting signals to the input of the Type 7A16. The Tektronix probes are shielded to prevent pickup of electrostatic interference. A 10× attenuator probe offers a high input impedance and allows the circuit under test to perform very close to normal operating conditions. However, a 10× probe also attenuates the input signal ten times. To obtain maximum bandwidth when using probes, observe the grounding considerations given in the probe manuals. The probe-to-connector adapters and the bayonet-ground tip provide the best frequency response. Remember that a ground strap only a few inches in length can produce several percent of ringing when operating at the higher frequency limit of this system (see Fig. 2-3).

In high-frequency applications requiring maximum overall bandwidth, use a coaxial cable terminated at both ends in the characteristic impedance of the cable. To maintain the high-frequency characteristics of the applied signal, use high-quality, low-loss cable. Resistive coaxial attenuators can be used to minimize reflections if the applied signal has suitable amplitude.

TYPE 7A16 AMPLIFIER SETUP CHART

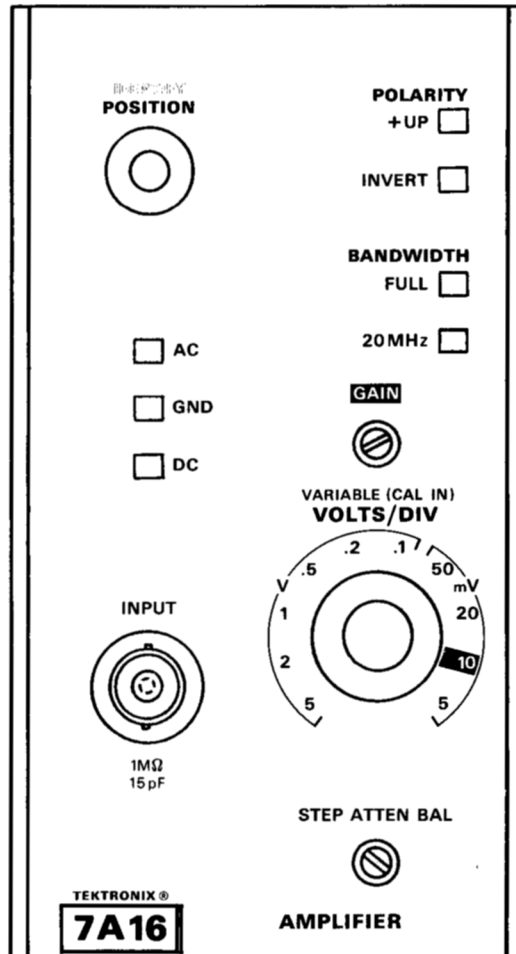

Fig. 2-2. Control setup chart.

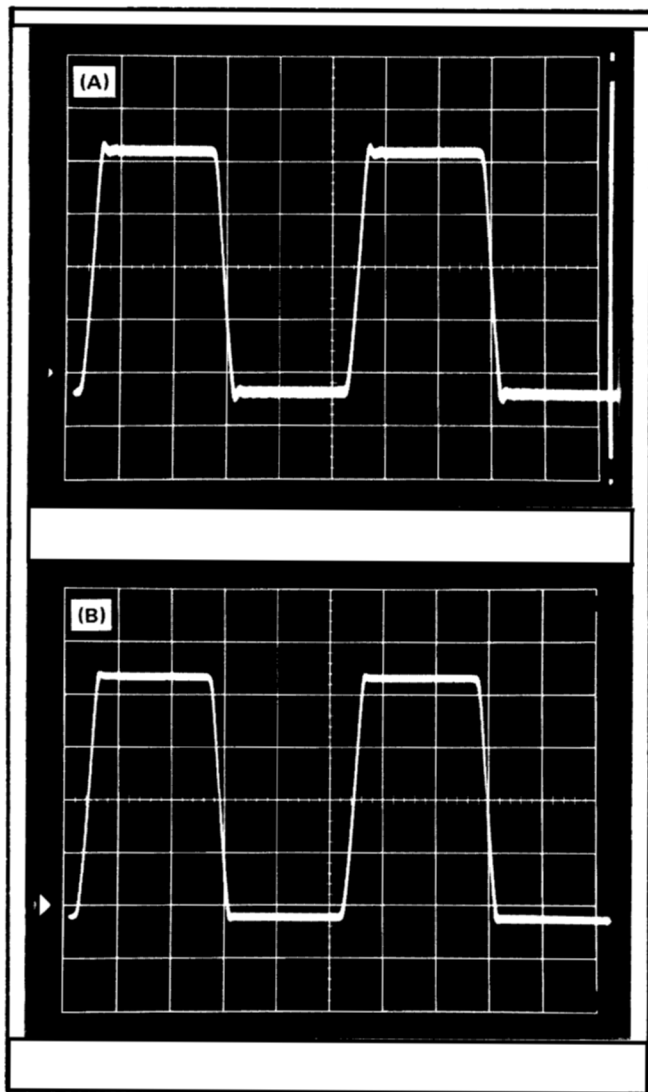

Fig. 2-3. Waveform distortion produced with incorrect probe ground. (A) Eighteen-inch ground strap between generator and oscilloscope. (B) Five-inch ground strap.

High-level, low-frequency signals can be connected directly to the Type 7A16 INPUT connector with short unshielded leads. This coupling method works best for signals below about one kilohertz and deflection factors above one volt/division. When this method is used, establish a common ground between the Type 7A16 and the equipment under test (common ground provided by line cords is usually inadequate). Attempt to position the leads away from any source of interference to avoid errors in the display. If interference is excessive with unshielded leads, use a coaxial cable or a probe.

Input Coupling

The AC-DC-GND pushbutton switch allows a choice of input coupling. The type of display desired determines the mode of input coupling used. The DC position can be used for most applications. However, if the DC component of the signal is much larger than the AC component, the AC position will probably provide a better display. DC coupling

should be used to display AC signals below about 10 hertz as they will be attenuated in the AC position.

In the AC position, the DC component of the signal is blocked by a capacitor in the input circuit. The low-frequency response in the AC position is about 10 hertz (—3 dB point). Therefore, some low-frequency distortion can be expected near this frequency limit. Distortion will also appear in square waves which have low-frequency components.

The GND position provides a ground reference at the input of the Type 7A16. The signal applied to the INPUT connector is internally disconnected but not grounded. The input circuit is held at ground potential, eliminating the need to externally ground the input to establish a DC ground reference.

The GND position is also used to pre-charge the coupling capacitor to the average voltage level of the signal applied to the INPUT connector. The pre-charging network allows the input-coupling capacitor to charge to the DC source voltage level when the Input Coupling switch is set to GND. The procedure for using this feature is as follows:

1. Before connecting the signal containing a DC component to the Type 7A16 INPUT connector, push the Input Coupling GND button. Then connect the signal to the INPUT connector.
2. Allow about one second for the coupling capacitor to charge.
3. Push the Input Coupling AC button. The trace (display) will return on the screen and the AC component of the signal can be measured in the normal manner.

Deflection Factor

The amount of vertical deflection produced by a signal is determined by the signal amplitude, the attenuation factor of the probe (if used), the setting of the VOLTS/DIV switch and the setting of the VARIABLE VOLTS/DIV control. The calibrated deflection factors indicated by the VOLTS/DIV switch apply only when the VARIABLE control is in the calibrated (pushed in) position.

The VARIABLE VOLTS/DIV control provides uncalibrated vertical deflection between the calibrated settings of the VOLTS/DIV switch. The VARIABLE control extends the maximum vertical deflection factor of the Type 7A16 to at least 12.5 volts/division (5V position).

The GAIN control, a front-panel screwdriver adjustment, sets the gain of the Type 7A16 Amplifier. The vertical deflection of the unit should be checked for accuracy prior to making critical measurements, using either the indicator unit Calibrator or a Standard Amplitude Calibrator (067-0502-00). If adjustment is necessary, the GAIN control should be adjusted with the VOLTS/DIV switch in the 10 mV position. Apply a 40 millivolt Calibrator signal to the INPUT and adjust GAIN for four divisions of display.

Step Attenuator Balance

To check the step attenuator balance, push the Input Coupling GND button and set the time-base triggering controls to provide a free-running trace. Change the VOLTS/DIV switch from 20 mV to 5 mV. If the trace moves vertically, adjust the front-panel STEP ATTEN BAL adjustment as follows (allow

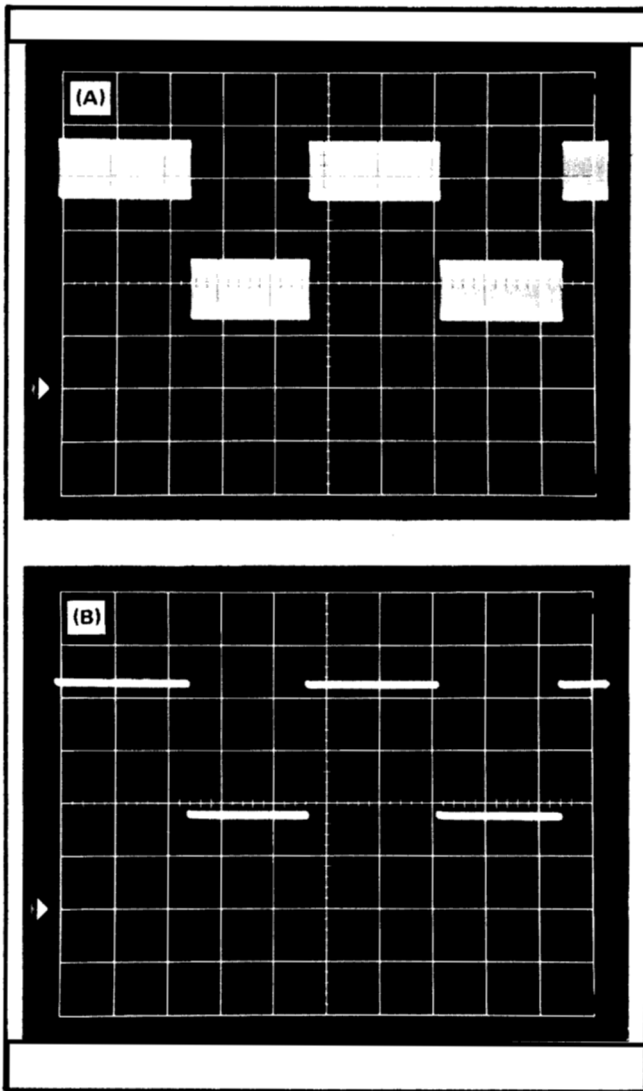

Fig. 2-4. (A) CRT display showing high-frequency interference when attempting to view low-level, low-frequency signal, (B) resultant display when 20 MHz pushbutton is pressed.

at least ten minutes warmup before performing this adjustment):

1. With the Input Coupling GND button pressed and the VOLTS/DIV switch set to 20 mV, move the trace to the center horizontal line of the graticule with the vertical POSITION control.
2. Set the VOLTS/DIV switch to 5 mV and adjust the STEP ATTEN BAL adjustment to return the trace to the center horizontal line.
3. Recheck step attenuator balance and repeat adjustment until no trace shift occurs as the VOLTS/DIV switch is changed from 20 mV to 5 mV.

Signal Polarity

The POLARITY switch provides a means of inverting the display. With the +UP button pressed, a positive-going

voltage at the INPUT produces a positive deflection on the CRT. With the INVERT button pressed, a positive-going voltage at the INPUT produces a negative deflection on the CRT. However, when observing a symmetrical waveform, such as the Calibrator square wave, inverting the signal makes no apparent change in the display. This is due to the time-base unit triggering on the indicated slope of the displayed waveform.

Bandwidth Limiter

The bandwidth switch provides a method of reducing interference from unwanted high-frequency signals when viewing low-frequency signals. With the FULL button pressed, the full bandwidth capabilities of the amplifier are available. When the 20 MHz button is pressed, the upper -3dB bandwidth point of the amplifier is limited to about 20 megahertz. The unwanted high-frequency signals (such as television broadcast radiation interference) are reduced in the displayed waveform. Fig. 2-4 illustrates the use of this feature. The waveform in Fig. 2-4A is the display produced when a low-level, low-frequency signal is viewed in the presence of a strong 50-megahertz radiation (FULL button pressed). Fig. 2-4B shows the resultant CRT display when the high-frequency interference is reduced by pressing the 20 MHz button.

Display Identification

When the Type 7A16 IDENTIFY button is pressed, the CRT display is deflected upward about 0.25 division for identification. This feature is particularly useful when the Type 7A16 is used with an indicator unit designed for use with more than one vertical amplifier.

When using an oscilloscope system equipped with the readout feature, information such as polarity, deflection factor, etc. is displayed on the CRT. When the Type 7A16 IDENTIFY button is pressed, the readout information pertaining to the Type 7A16 is replaced by the word IDENTIFY.

BASIC APPLICATIONS

The following information describes the procedure and technique for making basic measurements with a Type 7A16 Amplifier. These applications are not described in detail, since each application must be adapted to the requirements of the individual measurements. Familiarity with the Type 7A16 will permit these basic techniques to be applied to a wide variety of uses.

Peak-to-Peak Voltage Measurements—AC

To make a peak-to-peak voltage measurement, use the following procedure:

1. Connect the signal to the INPUT connector.
2. Push the Input Coupling AC button.
3. Set the VOLTS/DIV switch to display about five divisions of the waveform. Make sure the VARIABLE VOLTS/DIV control is in the calibrated (pushed in) position.

NOTE

For low-frequency signals below about 10 hertz, push the DC button.

4. Set the triggering controls to obtain a stable display. Set the sweep rate to display several cycles of the waveform.

5. Turn the vertical POSITION control so the lower portion of the waveform coincides with one of the graticule lines below the center horizontal line, and the top of the waveform is within the viewing area. Move the display with the horizontal position control, so one of the upper peaks lies near the center vertical line (see Fig. 2-5).

6. Measure the divisions of vertical deflection from peak-to-peak.

NOTE

This technique may also be used to make measurements between two points on the waveform rather than peak-to-peak.

7. Multiply the distance measured in step 6 by the VOLTS/DIV switch setting. Also include the attenuation factor of the probe, if any.

Example. Assume a peak-to-peak vertical deflection of 4.6 divisions using a 10X attenuator probe and a VOLTS/DIV switch setting of .5V.

Using the formula:

$$\text{Volts peak to peak} = \text{vertical deflection (divisions)} \times \text{VOLTS/DIV setting} \times \text{probe attenuation factor}$$

Substituting the given values:

$$\text{Volts peak to peak} = 4.6 \times 0.5 \times 10$$

The peak-to-peak voltage is 23 volts.

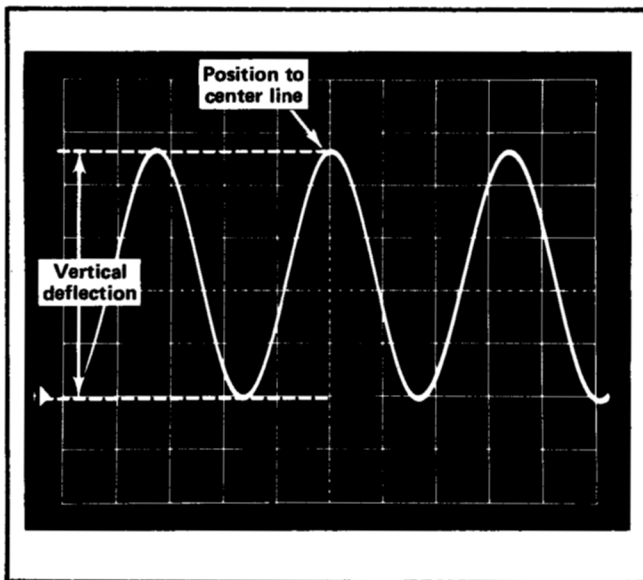

Fig. 2-5. Measuring peak-to-peak voltage of a waveform.

Instantaneous Voltage Measurements—DC

To measure the DC level at a given point on a waveform, use the following procedure:

1. Connect the signal to the INPUT connector.

2. Set the VOLTS/DIV switch to display about five divisions of the waveform. Make sure the VARIABLE VOLTS/DIV control is in the calibrated (pushed in) position.

3. Push the Input Coupling GND button.

4. Set the triggering controls to obtain a free-running trace.

5. Position the trace to the bottom line of the graticule or other reference line. If the voltage to be measured is negative with respect to ground, position the trace to the top line of the graticule. Do not move the vertical POSITION control after this reference line has been established.

NOTE

To measure a voltage level with respect to a voltage other than ground, make the following changes in step 5: Push the Input Coupling DC button and apply the reference voltage to the INPUT connector. Then position the trace to the reference line.

6. Push the Input Coupling DC button. The ground reference line can be checked at any time by pushing the GND button.

7. Set the triggering controls to obtain a stable display. Set the sweep rate to display several cycles of the signal.

8. Measure the distance in divisions between the reference line and the point on the waveform at which the DC level is to be measured. For example, in Fig. 2-6 the measurement is made between the reference line and point A.

9. Establish the polarity of the signal. If the waveform is above the reference line, the voltage is positive; below the line, negative.

10. Multiply the distance measured in step 8 by the VOLTS/DIV switch setting. Include the attenuation factor of the probe, if any.

Example. Assume that the vertical distance measured is 4.6 divisions, the waveform is above the reference line, using a 10X attenuator probe and a VOLTS/DIV switch setting of 2V.

Using the formula: Instantaneous Voltage =

$$\text{vertical distance (divisions)} \times \text{polarity} \times \text{VOLTS/DIV setting} \times \text{probe attenuation factor}$$

Substituting the given values:

$$\text{Instantaneous voltage} = 4.6 \times +1 \times 2V \times 10$$

The instantaneous voltage is +92 volts.

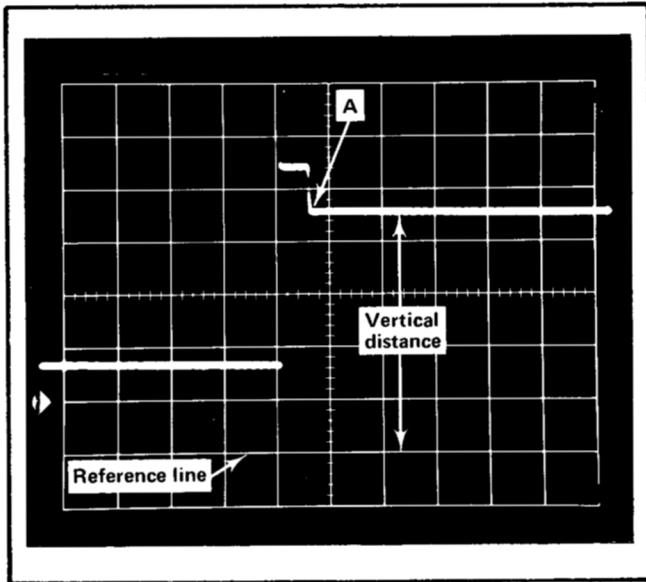

Fig. 2-6. Measuring instantaneous DC voltage with respect to a reference voltage.

Voltage Comparison Measurements

In some applications, it may be necessary to establish a set of deflection factors other than those indicated by the VOLTS/DIV switch. This is useful for comparing signals to a reference voltage amplitude. To establish a new set of deflection factors based upon a specific reference amplitude, proceed as follows:

1. Apply the reference signal of known amplitude to the INPUT connector. Using the VOLTS/DIV switch and the VARIABLE control, adjust the display for an exact number of divisions. Do not move the VARIABLE VOLTS/DIV control after obtaining the desired deflection.

2. Divide the amplitude of the reference signal (volts) by the product of the deflection in divisions (established in step 1) and the VOLTS/DIV switch setting. This is Deflection Conversion Factor.

$$\text{Deflection Conversion Factor} = \frac{\text{reference signal amplitude (volts)}}{\text{deflection (divisions)} \times \text{VOLTS/DIV setting}}$$

3. To determine the peak-to-peak amplitude of a signal compared to a reference, disconnect the reference and apply the signal to the INPUT connector.

4. Set the VOLTS/DIV switch to a setting that provides sufficient deflection to make the measurement. Do not re-adjust the VARIABLE VOLTS/DIV control.

5. To establish an Adjusted Deflection Factor at any setting of the VOLTS/DIV switch, multiply the VOLTS/DIV switch setting by the Deflection Conversion Factor established in step 2.

$$\text{Adjusted Deflection Factor} = \text{VOLTS/DIV setting} \times \text{Deflection Conversion Factor}$$

This Adjusted Deflection Factor is correct only if the VARIABLE VOLT/DIV control is not moved from the position set in step 1.

6. Measure the vertical deflection in divisions and determine the amplitude by the following formula:

$$\text{Signal Amplitude} = \frac{\text{Adjusted Deflection Factor}}{\text{Factor}} \times \text{deflection (divisions)}$$

Example. Assume a reference signal amplitude of 30 volts, a VOLTS/DIV setting of 5 and a deflection of four divisions. Substituting these values in the Deflection Conversion Factor formula (step 2).

$$\text{Deflection Conversion Factor} = \frac{30 \text{ V}}{4 \times 5 \text{ V}} = 1.5$$

Then, with a VOLTS/DIV switch setting of 2, the Adjusted Deflection Factor (step 5) is:

$$\text{Adjusted Deflection Factor} = 2 \text{ V} \times 1.5 = 3 \text{ volts/division}$$

To determine the peak-to-peak amplitude of an applied signal which produces a vertical deflection of five divisions, use the Signal Amplitude formula (step 6):

$$\text{Signal Amplitude} = 3 \text{ V} \times 5 = 15 \text{ volts}$$

SECTION 3

CIRCUIT DESCRIPTION

Change information, if any, affecting this section will be found at the rear of this manual.

Introduction

This section of the manual contains a description of the circuitry used in the Type 7A16 amplifier. The description begins with a discussion of the instrument using the block diagrams shown in the Diagrams section. Then each circuit is described in detail using the block diagram to show interconnections between the circuits and the relationship of the frontpanel controls to the individual stages.

Complete schematics of each circuit are given in the Diagrams section. Refer to these diagrams throughout the following circuit description for electrical values and relationship.

BLOCK DIAGRAM DESCRIPTION

The following discussion is provided to aid in understanding the overall concept of the Type 7A16 before the individual circuits are discussed in detail. Each block on the Block Diagram, located in the Diagrams section, represents an individual circuit within the instrument. The number on

each block refers to the diagram on which the complete circuit is found.

The signal to be displayed on the CRT is applied to the INPUT connector, through the input coupling circuit to the VOLTS/DIV switch. The VOLTS/DIV switch provides the appropriate input attenuation and applies the signal to the first stage of the Input Amplifier. The signal is coupled through two emitter followers, Q40-Q50, to the First Cascode stage, which operates as a phase-splitter. The First Cascode stage, Q60A-Q70-Q60B-Q90, contains variable gain circuits and bandwidth limiting circuits.

The Second Cascode Stage, Q100A-Q120A-Q100B-Q120B, provides gain-switching, signal polarity inversion, and vertical positioning. The gain-switching relays in the two cascode stages are operated by the VOLTS/DIV switch which, with the input attenuators, sets the overall gain of the amplifier. Additional amplification is provided by the Output Amplifier, Q125-Q140-Q165-Q180. The Trigger Pickoff circuit, Q130-Q135-Q170-Q175, takes the signal from the emitters of Q125-Q165 and amplifies it to provide + and - trigger signals for the time base unit.

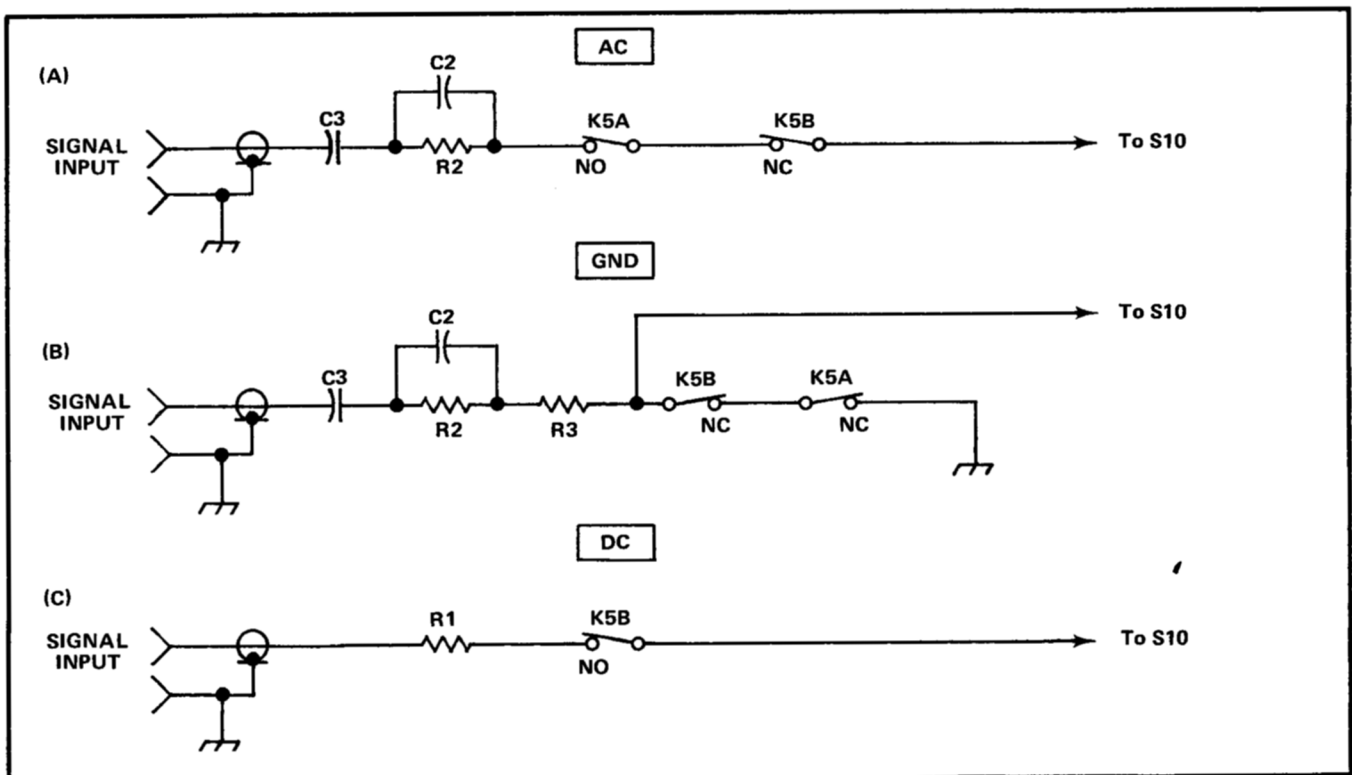

Fig. 3-1. Signal paths through input COUPLING switch.

Circuit Description—Type 7A16

In addition to the functions of the amplifier just explained, the Type 7A16 also provides readout logic for the indicator oscilloscope, Logic identifying the Polarity and the deflection factor, whether calibrated or uncalibrated is supplied. When the IDENTIFY button is pressed, the readout is replaced with the word IDENTIFY. At the same time, the collector of Q120B is grounded through R200, shunting some of the collector current which moves the trace upward approximately 0.25 division.

DETAILED CIRCUIT DESCRIPTION

Input Coupling

Input signals applied to the INPUT connector can be AC-coupled, DC-coupled, or internally disconnected. The input coupling relay, K5, a dual pole alternate throw relay, is operated by S3, a three-position pushbutton switch. Only one side of the DPAT relay operates at a time. When the AC button is pressed, K5A is actuated providing a signal path from the INPUT connector through C3-K5A-K5B-C2-R2 (see Fig. 3-1A). In this position, C3 prevents the DC component of the signal from passing to the amplifier. When the DC button is pressed, K5B is actuated, providing a signal path directly through K5B to R1 (see Fig. 3-1C). When the GND button is pressed, the input signal is AC-coupled through C3 and R3 to ground. The input circuit is grounded to provide a zero volts reference level (see Fig. 3-1B). Resistor R3 allows C3 to be precharged in the GND position so the trace remains on screen when the AC button is pressed with a high DC level applied.

Input Attenuator

The effective overall deflection factor of the Type 7A16 is determined by the VOLTS/DIV switch attenuators and the gain-switching relays, K105-K110-K155-K160. The 5 mV, 10 mV, and 20 mV switch positions employ $1\times$ attenuators. In all positions of the VOLTS/DIV switch above 20 mV, the basic deflection factor of the vertical deflection system is 20 millivolts per division of deflection. To increase this basic deflection factor to the values indicated on the front panel, precision attenuators are switched into the input circuit. The positions of the VOLTS/DIV switch and the corresponding attenuators are as follows:

5 mV	$1\times$.2 V	$10\times$
10 mV	$1\times$.5 V	$25\times$
20 mV	$1\times$.1 V	$50\times$
50 mV	$2.5\times$	2 V	$100\times$
.1 V	$5\times$	5 V	$250\times$

The Input Attenuators, with R14-C14-R17-R18-C18 form frequency-compensated voltage dividers. For DC and low-frequency signals, they are primarily resistance dividers and the voltage attenuation is determined by the resistance ratio in the circuit. The reactance of the capacitors in the circuit is so high at low frequencies that their effect is negligible. However, at higher frequencies, the reactance of the capacitors decreases and the attenuator becomes primarily a capacitance voltage divider.

In addition to providing constant attenuation at all frequencies within the bandwidth of the system, the Input Attenuators are designed to maintain the same input RC

characteristics (one megohm \times 15 pF) for each setting of the VOLTS/DIV switch. The attenuators contain adjustable shunt capacitors to provide input capacitance.

Input Stage

The signal from the Input Attenuator is connected to the Input Stage through the network R14-C14-R17-R18-C18. These resistors are part of the attenuation network at all VOLTS/DIV switch positions. Variable capacitor C18 adjusts the basic input time constant for a nominal value of one megohm \times 15 picofarads. R14-C14 isolate the input from the gate of the input field-effect transistor, Q20. Resistor R14 also limits the gate current of Q20.

FET Q20B is a constant current source for the source follower, Q20A. The DC Bal adjustment, R34, varies the gate level of Q20B to provide a zero volt level at the base of Q60A with no signal applied. Low-frequency by-pass capacitors C34 and C36, with L34, filter noise from the gate of Q20B. L20-C20 and L30-C30 are decoupling networks. Damping for Q20A is provided by R23. The source of Q20A is isolated from the base of Q40 by R28-C28. Resistor R28 sets the bias of Q20A, preventing the gate from going more positive than the source. Damping for Q20B is provided by R38. The bias for Q20B is set by R30. Diode CR29 clamps the gate of Q20A at about -12 volts, protecting the FET from large negative voltage swings.

Two emitter followers, Q40 and Q50 couple the input signal through R52-C52 to the First Cascode Stage. Capacitors C45 and C52 are adjustable for high frequency peaking. In the collector of each of the emitter followers is a damping adjustment. Maximum damping for Q40 is achieved when R40 is adjusted away from the collector of Q40. Maximum damping for Q50 is achieved when R55 is adjusted away from the collector of Q50. These two damping adjustments are set for a compromise between maximum risetime and minimum ringing. Capacitors C23 and C56 assure that no feedback signals are seen by the input FETs.

First Cascode Stage

The first cascode stage is a paraphase amplifier. With R34 adjusted for zero volts at the base of Q60A, the quiescent current through both sides of the paraphase amplifier is approximately 10 milliamperes. The input signal drives the base of Q60A, and the base of Q60B is grounded through R82. A positive signal at the base of Q60A increases the current through R60-Q60A-R68-R71-Q70-R100 and reduces the current through R80-Q60B-R88-R90-Q90-R150, producing push-pull signals at the bases of Q100A and Q100B. Resistor R68, paralleled by C68-L68, and R88, paralleled by C88-L88, provide thermal balance for the stage. Resistors R70, R71 and R90 provide damping. The divider R73-R74 sets the base voltage of Q70 and Q90 at approximately 6.7 V. The common-emitter circuit contains two high-frequency peaking adjustments, C61 and R61.

The voltage gain of this stage, from single-ended to push-pull, is approximately 1.6 and is set by the ratio of R100 or R150 to R60 and R80. With K65 as shown (VARIABLE pushed in), the exact gain of the amplifier is set by R66 (VOLTS/DIV switch set to 10 mV), which adjusts the amount of shunt current through R64-R66-R84. Relay K65, actuated in the uncalibrated position, switches in the R65-R85-R86

network and switches out the R64-R66-R84 network. The VARIABLE control (R86) affects the gain of the amplifier by a greater degree than R66, due to the comparatively small values of R65 and R85. With R86 set to minimum resistance, the gain of the amplifier is reduced by a factor of at least 2.5. The Var Gain Bal control, R89, is adjusted for no trace shift when K65 is switched.

With the BANDWIDTH switch FULL button pressed, the output of the first cascode stage is connected directly through K75 to the second cascode stage. With the 20 MHz button pressed, the bandwidth limiting circuit, C77-C97-L76-L96-L97, is switched in by K75. This sets the upper frequency limit of the amplifier to approximately 20 MHz.

Second Cascode Stage

The second cascode stage, formed by Q100A-Q120A-Q100B-Q120B, contains gain switching, signal inversion, and vertical positioning circuits. The gain of this stage in the 5 mV position of the VOLTS/DIV switch is set by the ratio of R123 or R163 to R102 or R151. With the POSITION control and R117 set to midrange, the quiescent current through Q100A and Q100B is approximately 15 milliamperes, set by R104-R106-R156. The quiescent current through Q120A and Q120B is approximately 10 milliamperes, set by R118-R166. In the 10 mV position, K110 and K160 switch in shunt resistor R161, reducing the gain by a factor of two. In the 20 mV position, K105 and K155 switch in shunt resistor R159 and series resistors R108 and R158, reducing the gain by an additional factor of two. The deflection factor at the output of this stage is 15 mV/Div per side.

The emitter circuit of Q100A-Q100B contains high-frequency peaking adjustments C102-R103-C103. Compensation in the 10 mV position is provided by C111-R111. Additional compensation in the 20 mV position is provided by C109-R109. Thermal compensation networks for Q100A and Q100B are formed by R105-C105 and R155-C155. Resistors R106 and R156 set the voltage drop across the gain-setting dividers to zero volts. The Step Atten Bal control, R153, is adjusted for no trace shift when switching K105 and K155 or K110 and K160. Thermal compensation networks for Q120A and Q120B are formed by C124-R124 and C164-R164.

The polarity inversion circuit consists of a DPDT relay, K115, and a front panel push-button POLARITY switch. With the +UP button pressed, the relay is as shown in the schematic. With the INVERT button pressed, K115 is actuated, inverting the signal outputs and the trigger outputs.

The vertical POSITION control, R115, applies DC voltages of opposite polarity to the two sides of the amplifier through R114 and R160. This offset voltage is DC-coupled to the output moving the trace upward or downward on the CRT. With the vertical POSITION control set to midrange, the position centering network, R117-R118-R168, applies a positive voltage to one side of the amplifier, centering the trace vertically on the CRT.

Output Stage

The output stage consists of the emitter-feedback and shunt-feedback amplifiers, Q125-Q165 and Q140-Q180, and the trigger pick-off amplifier Q130-Q135-Q170-Q175. The gain of the output amplifier is approximately five, set by

the ratio of R142-R182 to R128-R168. Thermistor (RT128) and Varactors (CR128-CR168) provide proper compensation for transient response variations with temperature. Thermal compensation for Q125 and Q165 is provided by R125-C125 and R165-C165. Resistor R129 provides the DC current source for Q125 and Q165. Decoupling for the output amplifier is provided by L140 and C140. The -15 volt supply is decoupled in the common-emitter circuit of Q140-Q180 by L143 and C143. R141-R181-R143 provide approximately 18 milliamperes DC current for each output transistor. The output signals are reverse terminated by C145-R145 and C185-R185. These networks, with the 50-ohm terminations in the indicator oscilloscope, produce an output deflection factor of 25 millivolts/division per side.

The trigger pickoff amplifier takes the output signal from the emitters of Q125 and Q165 and amplifies it to a level near that of the output amplifier. Resistor R131 sets the DC current for Q130 and Q170 through R130 and R170 respectively. Capacitor C130 provides high-frequency peaking. Thermal compensation for Q130 and Q170 is provided by C133-R133 and C173-R173. Divider R172-R174-R137-R177 provides approximately 15 milliamperes each for Q135-Q175. The output signal from the trigger pickoff amplifier is reverse terminated by C138-R138 and C178-R178.

Readout Block

The readout block consists of switching resistors and a probe sensing device. The switching resistors, selected by the setting of the Readout Switch (part of the VOLTS/DIV switch), are used to signal the Indicator Oscilloscope the setting of the VOLTS/DIV switch.

Refer to Schematic Diagram 4 (Section 7), Switching and Interconnecting Plug, to find the resistors associated with a particular setting of the VOLTS/DIV switch. The number 1, 2, or 5 is selected by R207-R208-R209. R207 selects the numeral 1, R207-R208 selects the numeral 2, and R207-R209 selects the numeral 5. R226-R228-R234 and the output of the probe sensing device (Q200) selects the decimal point (number of zeroes). R224-R225, when switched in, gives the Volts sub-unit m (milli). R205-R206 selects the symbol V (volts). R218-R220 selects the symbol > when the VARIABLE VOLTS/DIV knob is in the uncalibrated position. R219-R222 selects the symbol † when the INVERT pushbutton is pressed in.

The probe connected to the INPUT connector forms a voltage divider with R202 to the -15 volt supply. The amount of probe resistance will determine the bias applied to the base of Q200.

With a 1× probe connected, Q200 is biased off by the -15 volt supply, and the deflection factor (in the readout display) is determined by the setting of the Readout Switch (part of the VOLTS/DIV switch).

With a 10× probe connected to the INPUT connector, the bias applied to the base of Q200 will allow 100 μA of collector current to flow. When the clock pulse interrogates interface connector B33, this current is added to the current corresponding to the setting of the Readout Switch to increase the deflection factor (in the displayed readout) by 10.

The Indicator Oscilloscope displayed readout will give the correct deflection factor from the probe tip (using the

Circuit Description—Type 7A16

recommended attenuator probes) whereas the VOLTS/DIV knob on the Plug-In will display only the Plug-In deflection factor.

The trace IDENTIFY button, when pressed, does two things:

1. It causes the trace, representing the output of the Type 7A16, to move upward a small amount by inserting R200 from the collector of Q120B to ground. This shunts a small amount of the collector current causing the trace to move.
2. It also grounds the base of Q200. This causes Q200

to turn on hard erasing the displayed readout and causing the word IDENTIFY to appear.

These two actions aid in identifying the Type 7A16 trace when multiple traces are displayed. When the IDENTIFY button is released, the readout is restored to its previous display.

For more specific information on the operation of the Indicator Oscilloscope refer to the appropriate Indicator Oscilloscope Manual.

SECTION 4

MAINTENANCE

Change information, if any, affecting this section will be found at the rear of the manual.

Introduction

This section of the manual contains maintenance information for use in preventive maintenance, corrective maintenance and troubleshooting of the Type 7A16.

PREVENTIVE MAINTENANCE

General

Preventive maintenance consists of cleaning, visual inspection, lubrication, etc. Preventive maintenance performed on a regular basis may prevent instrument breakdown and will improve the reliability of this instrument. The severity of the environment to which the Type 7A16 is subjected determines the frequency of maintenance. A convenient time to perform preventive maintenance is preceding recalibration of the instrument.

Cleaning

The Type 7A16 should be cleaned as often as operating conditions require. Accumulation of dirt in the instrument can cause overheating and component breakdown. Dirt on components acts as an insulating blanket and prevents efficient heat dissipation. It may also provide an electrical conduction path.

The covers of the indicator oscilloscope minimize the amount of dust which reaches the interior of the Type 7A16. Operation of the system without the indicator oscilloscope covers in place necessitates more frequent cleaning. When the Type 7A16 is not in use, it should be stored in a protected location such as a dust-tight cabinet.

CAUTION

Avoid the use of chemical cleaning agents which might damage the plastics used in this instrument. Avoid chemicals which contain benzene, toluene, xylene, acetone or similar solvents.

Exterior. Loose dust accumulated on the outside of the Type 7A16 can be removed with a soft cloth or small paint brush. The paint brush is particularly useful for dislodging dirt on and around the front-panel controls. Dirt which remains can be removed with a soft cloth dampened in a mild detergent and water solution. Abrasive cleaners should not be used.

Interior. Dust in the interior of the instrument should be removed occasionally due to its electrical conductivity under high-humidity conditions. The best way to clean the interior is to blow off the accumulated dust with dry, low-velocity air. Remove any dirt which remains with a soft paint brush or a cloth dampened with a mild detergent and water solution. A cotton-tipped applicator is useful for cleaning in narrow spaces.

Lubrication

General. The reliability of potentiometers and other moving parts can be maintained if they are kept properly lubricated. Potentiometer shaft bushings should be lubricated with a light-weight lubricant (e.g., Tektronix Part No. 006-0172-00). Do not over lubricate. A lubrication kit containing the necessary lubricants and instructions is available from Tektronix, Inc. Order Tektronix Part No. 003-0342-01.

Visual Inspection

The Type 7A16 should be inspected occasionally for such defects as broken connections, broken or damaged circuit boards, improperly seated transistors or relays, and heat-damaged parts.

The corrective procedure for most visible defects is obvious; however, particular care must be taken if heat-damaged components are found. Overheating usually indicates other trouble in the instrument; therefore, it is important that the cause of overheating be corrected to prevent a recurrence of the damage.

Transistor Checks

Periodic checks of the transistors in the Type 7A16 are not recommended. The best check of transistor performance is actual operation in the instrument. More details on checking transistor operation is given under Troubleshooting.

Recalibration

To ensure accurate measurements, check the calibration of this instrument after each 1000 hours of operation or every six months if used infrequently. In addition, replacement of components may necessitate recalibration of the affected circuits. Complete calibration instructions are given in Section 5.

The Performance Check/Calibration Procedure can also be helpful in localizing certain troubles in the instrument. In some cases, minor troubles may be revealed and/or corrected by calibration.

TROUBLESHOOTING

Introduction

The following information is provided to facilitate troubleshooting of the Type 7A16. Information contained in other sections of this manual should be used along with the following information to aid in locating the defective component.

An understanding of the circuit operation is very helpful in locating troubles. See the Circuit Description section for complete information.

Troubleshooting Aids

Diagrams. Circuit diagrams are given on foldout pages in section 7. The component number and electrical value of each component in this instrument are shown on the diagrams.

Switch Wafer Identification. Switch wafers shown on the diagrams are coded to indicate the position of the wafer in the complete switch assembly. The numbered portion of the code refers to the wafer number counting from the front, or mounting end of the switch, toward the rear. The letters F and R indicates whether the front or rear of the wafer performs the particular switching function. For example, a wafer designated 2R indicates that the rear of the second wafer is used for this particular switching function.

Wiring Color-Code. All insulated wire and cable used in the Type 7A16 is color-coded to facilitate circuit tracing. Signal carrying leads are identified with one or two colored stripes on white insulation. Voltage supply leads have colored insulation indicating the polarity of the supply; red for positive supplies, violet for negative supplies. The stripe on a voltage lead indicates the number of the supply, using the

EIA color code, counting in sequence from ground all supplies in the oscilloscope system. The +15-volt supply lead is identified by a brown stripe on red insulation, indicating the second positive supply from ground. (The +5-volt supply is the first positive supply.) The -15-volt supply lead is identified by a black stripe on violet insulation.

Resistor Color-Code. Brown composition resistors and metal-film resistors are used in the Type 7A16. The resistance values of composition resistors and metal-film resistors are color coded on the components (some metal-film resistors may have the value printed on the body) with EIA color-code. The color code is read starting with stripe nearest the end of the resistor. Composition resistors have four stripes which consist of two significant figures, a multiplier and a tolerance value (see Fig. 4-1). Metal-film resistors have five stripes consisting of three significant figures, a multiplier and a tolerance value.

Capacitor Marking. The capacitance values of common disc capacitors and small electrolytics are marked in microfarads on the side of the component body. The white ceramic capacitors used in the Type 7A16 are color coded in picofarads using a modified EIA code (see Fig. 4-1).

Diode Color Code. The cathode end of each glass-encased diode is indicated by a stripe, a series of stripes or a dot. For most silicon or germanium diodes with a series of stripes, the color code also indicates the type of diode

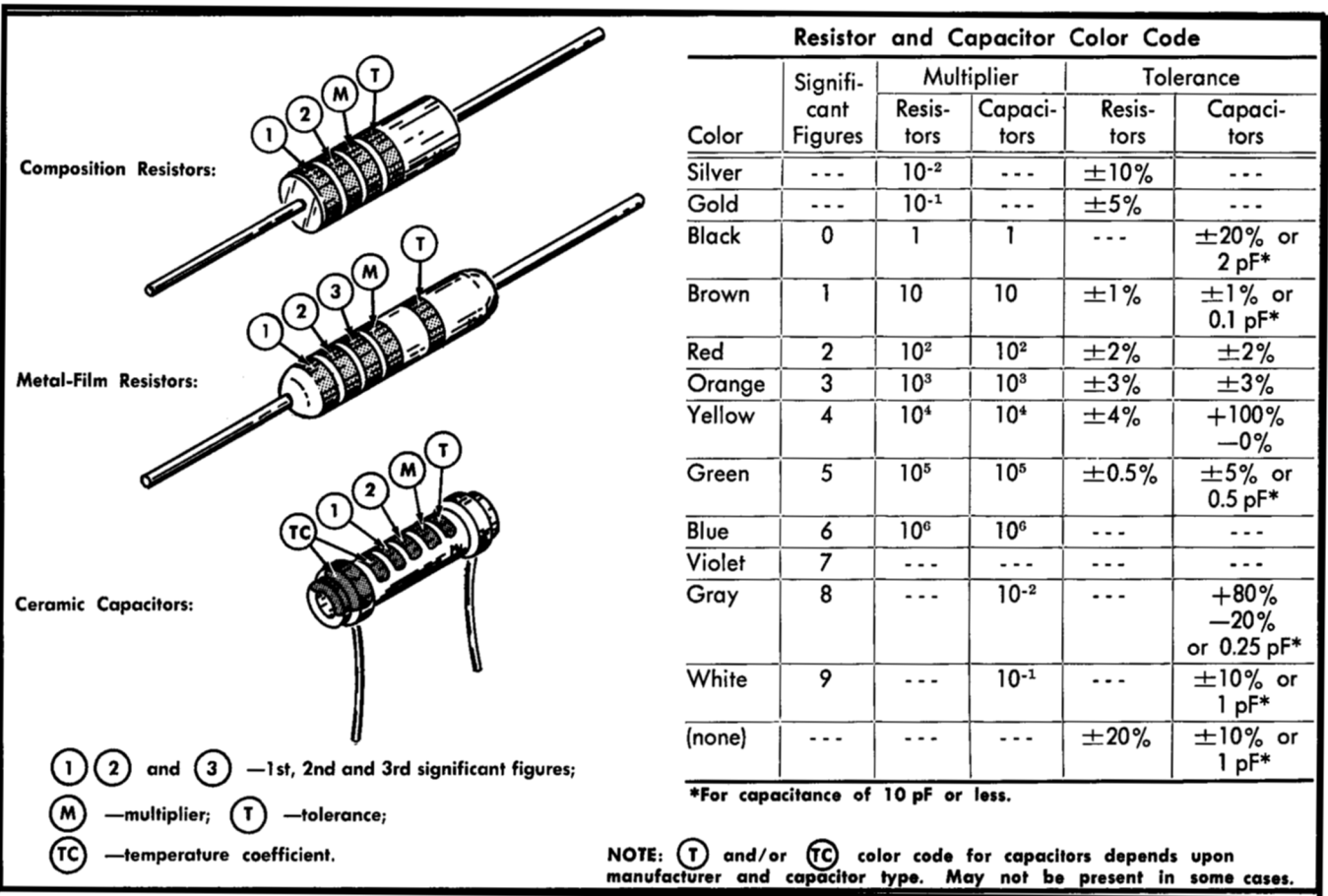

Fig. 4-1. Color-code for resistors and ceramic capacitors.

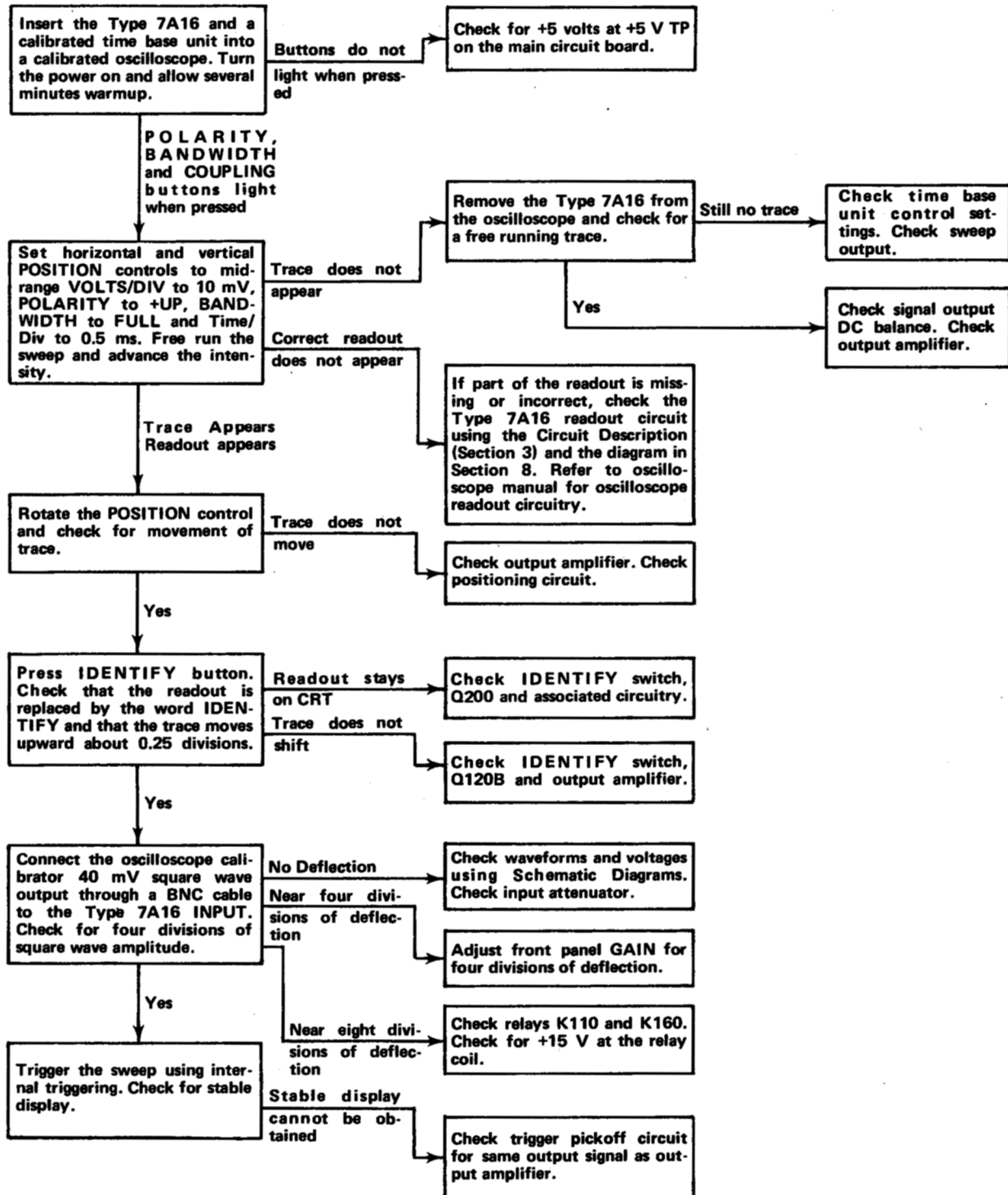

Fig. 4-2. Troubleshooting chart for Type 7A16.

Maintenance—Type 7A16

or identifies the Tektronix Part Number using the resistor color-code system (e.g., a diode color coded blue- or pink-brown-gray-green indicates Tektronix Part Number 152-0185-00). The cathode and anode end of metal-encased diodes can be identified by the diode symbol marked on the body.

Troubleshooting Equipment

The following equipment is useful for troubleshooting the Type 7A16.

1. Transistor Tester

Description: Tektronix Type 576 Transistor-Curve Tracer or equivalent.

Purpose: To test the semiconductors used in this instrument.

2. Volt-ohmmeter

Description: 20,000 ohm/volt. 0-500 volts DC. Accurate within 3%. Test probes must be well insulated.

Purpose: To measure voltages and resistances.

3. Test Oscilloscope

Description: DC to 50 MHz frequency response, 5 millivolts to 5 volts/division deflection factor. Use a 10× probe.

Purpose: To check waveforms in the instrument.

4. Plug-In Extension

Description: Rigid plug-in extender, Tektronix Part Number 067-0589-00.

Purpose: Permits operation of the unit outside the plug-in compartment for better accessibility during troubleshooting.

Troubleshooting Techniques

This troubleshooting procedure is arranged in an order which checks the simple trouble possibilities before proceeding with extensive troubleshooting. The first few checks ensure proper connection, operation and calibration. If the trouble is not located by these checks, the remaining steps aid in locating the defective component. When the defective component is located, it should be replaced following the replacement procedures given under Corrective Maintenance.

1. Check Control Settings. Incorrect control settings can indicate a trouble that does not exist. If there is any question about the correct function or operation of any control, see the Operating Instructions section.

2. Check Associated Equipment. Before proceeding with troubleshooting of the Type 7A16, check that the equipment used with this instrument is operating correctly. Check that the signal is properly connected and that the interconnecting cables are not defective. The indicator oscilloscope and time-base plug-in unit can be checked for proper operation by substituting another vertical unit which is known to be operating properly (preferably another Type 7A16 or similar unit). If the trouble persists after substitution, the indicator oscilloscope and/or time-base plug-in unit is defective.

3. Check Instrument Calibration. Check the calibration of this instrument, or the affected circuit if the trouble exists in one circuit. The apparent trouble may only be a result of misadjustment or may be corrected by calibration. Com-

plete calibration instructions are given in the Calibration section.

4. Visual Check. Visually check the portion of the instrument in which the trouble is located. Many troubles can be located by visual indications such as unsoldered connections, broken wires, damaged components, etc.

5. Isolate Trouble to a Circuit. To isolate a trouble to a circuit, note the trouble symptom. The symptom often indicates the circuit in which the trouble is located. When trouble symptoms appear in more than one circuit, check all affected circuits by taking voltage and waveform readings. If the signal is correct, the circuit is working correctly up to that point.

Fig. 4-2 provides a guide to aid in locating a defective circuit. This chart does not include checks for all possible defects; use steps 6 and 7 for further troubleshooting. Start from the top of the chart and perform the given checks on the left side of the page until a step is found which is not correct. Further checks and/or the circuit in which the trouble is probably located are listed to the right of the step.

After the defective circuit has been located, proceed with steps 6 and 7 to locate the defective component(s).

6. Check Voltages and Waveforms. Often the defective component can be located by checking for the correct voltage or waveform in the circuit. Typical voltages and waveforms are given on the diagram.

NOTE

Voltages and waveforms given on the diagrams are not absolute and may vary slightly between instruments. To obtain operating conditions similar to those used to take these readings, see the first diagram page.

7. Check Individual Components. The following procedure describes methods of checking individual components in the Type 7A16. Components which are soldered in place are best checked by first disconnecting one end. This isolates the measurement from the surrounding circuitry.

A. RELAYS. There are three types of relays in the Type 7A16. They are the five-pin SPDT relay, Tektronix Part No. 148-0035-00, the eight-pin DPDT relay, Tektronix Part No. 148-0034-00, and the eight-pin DPAT relay, Tektronix Part No. 148-0063-00. These relays, which are plugged into the circuit board, may be removed and checked. Fig. 4-3 shows the internal configurations of the three relays. Using an ohmmeter, check for the indicated DC resistances. Each relay can be actuated by applying 15 volts to the coil, as shown in Fig. 4-3. With the relay actuated, check the normally open contacts for continuity. When checking the DPAT relay, the polarity of the 15 volt determines which side of the relay is actuated. When returning the relays to the circuit board, place the five-pin SPDT relays in the five-pin sockets. The eight-pin DPDT relays are symmetrical, hence may be placed in their sockets facing either direction. The eight-pin DPAT relay, which is not symmetrical, must be placed in the socket with the Tektronix Part Number facing toward the top of the instrument.

B. TRANSISTORS. The best check of transistor operation is actual performance under operating conditions. If a transistor is suspected of being defective, it can best be checked by substituting a new component or one which has been checked previously. However, be sure that circuit conditions are not such that a replacement transistor might also be

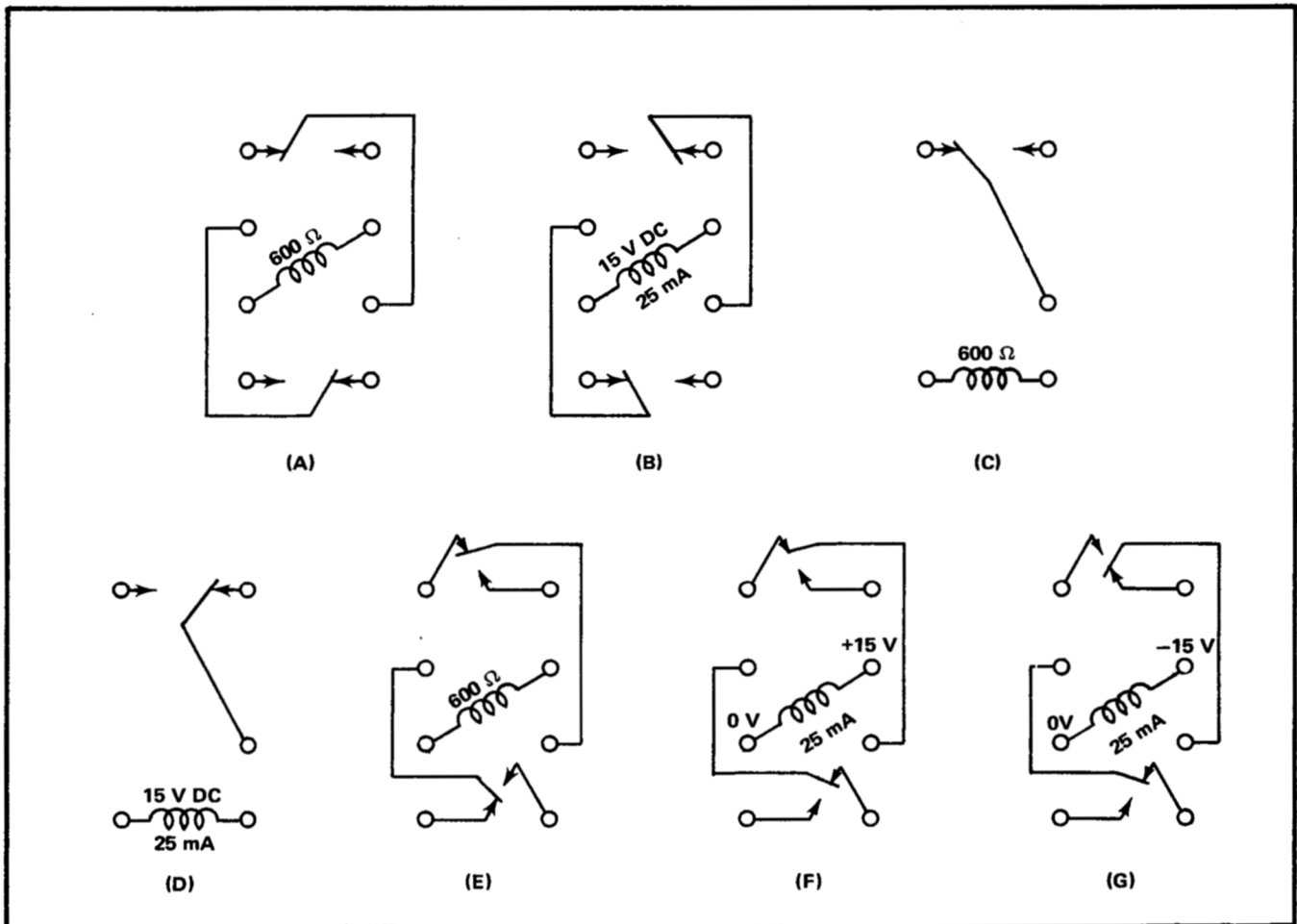

Fig. 4-3. Internal configuration of relays (pin views, with Tektronix Part Number on right), showing (A) DPDT relay not energized, (B) DPDT relay energized, (C) SPDT relay not energized, (D) SPDT relay energized, (E) dual SPDT relay not energized, (F) dual DPAT relay energized with +15 volts (AC button pressed), and (G) dual DPAT relay energized with -15 volts (DC button pressed).

damaged. If substitute transistors are not available, use a dynamic tester (such as Tektronix Type 576).

C. DIODES. A diode can be checked for an open or shorted condition by measuring the resistance between terminals. With an ohmmeter scale having an internal source of between 800 millivolts and 3 volts, the resistance should be very high in one direction and very low when the leads are reversed.

CAUTION

Do not use an ohmmeter scale that has a high internal current. High currents may damage the diode.

D. RESISTORS. Resistors can be checked with an ohmmeter. Check the Electrical Parts List for the tolerance of the resistors used in this instrument. Resistors normally do not need to be replaced unless the measured value varies widely from the specified value.

E. INDUCTORS. Check for open inductors by checking continuity with an ohmmeter. Shorted or partially shorted inductors can usually be found by checking the waveform response when high-frequency signals are passed through the

circuit. Partial shorting often reduces high-frequency response.

F. CAPACITORS. A leaky or shorted capacitor can best be detected by checking the resistance with an ohmmeter on the highest scale. Do not exceed the voltage rating of the capacitor. The resistance reading should be high after initial charge of the capacitor. An open capacitor can best be detected with a capacitance meter or by checking whether the capacitor passes AC signals.

8. Repair and Readjust the Circuit. If any defective parts are located, follow the replacement procedures given in this section. Be sure to check the performance of any circuit that has been repaired or that has had any electrical components replaced.

CORRECTIVE MAINTENANCE

General

Corrective maintenance consists of component replacement and instrument repair. Special techniques required to replace components in this instrument are given here.

Obtaining Replacement Parts

Standard Parts. All electrical and mechanical part replacements for the Type 7A16 can be obtained through your local Tektronix Field Office or representative. However, many of the standard electronic components can be obtained locally in less time than is required to order them from Tektronix, Inc. Before purchasing or ordering replacement parts, check the parts list for value, tolerance, rating and description.

NOTE

When selecting replacement parts, it is important to remember that the physical size and shape of a component may affect its performance in the instrument, particularly at high frequencies. All replacement parts should be direct replacements unless it is known that a different component will not adversely affect instrument performance.

Special Parts. In addition to the standard electronic components, some special parts are used in the Type 7A16. These parts are manufactured or selected by Tektronix, Inc., to meet specific performance requirements, or are manufactured for Tektronix, Inc., in accordance with our specifications. These special parts are indicated in the electrical parts list by an asterisk preceding the part number. Most of the mechanical parts used in this instrument have been manufactured by Tektronix, Inc. Order all special parts directly from your local Tektronix Field Office or representative.

Ordering Parts. When ordering replacement parts from Tektronix, Inc., include the following information:

1. Instrument Type.
2. Instrument Serial Number.
3. A description of the part (if electrical, include circuit number).
4. Tektronix Part Number.

Soldering Techniques

WARNING

Disconnect the instrument from the power source before soldering.

Circuit Boards. The components mounted on the circuit boards in the amplifier can be replaced using normal circuit board soldering techniques. Keep the following points in mind when soldering on the circuit boards:

1. Use a pencil-type soldering iron with a power rating from 15 to 50 watts.
2. Apply heat from the soldering iron to the junction between the component and the circuit board.
3. Heat-shunt the lead of the component by means of a pair of long-nosed pliers.
4. Avoid excessive heating of the junction with the circuit board, as this could separate the circuit board wiring from the laminate.

5. Use electronic grade 60-40 tin-lead solder.
6. Clip off any excess lead length extending beyond the circuit board and clean off any residual flux with a flux-removing solvent. Be careful that the solvent does not remove any printing from the circuit board.

Metal Terminals. When soldering metal terminals (e.g., switch terminals, potentiometers, etc), use 60-40 tin lead solder and a 15 to 50 watt soldering iron. Observe the following precautions when soldering metal terminals:

1. Apply only enough heat to make the solder flow freely.
2. Apply only enough solder to form a solid connection. Excess solder may impair the function of the part.
3. If a wire extends beyond the solder joint, clip off the excess.
4. Clean the flux from the solder joint with a flux-removing solvent.

Component Replacement

WARNING

Disconnect the test equipment from the power source before replacing components.

Relay Replacement. The relays in the Type 7A16 are manufactured by Tektronix, Inc. If a relay fails, a replacement may be ordered from your local Tektronix Field Office or representative. The five-pin relay sockets on the circuit board will accept only the five-pin SPDT relay. It is possible, however, to place a five-pin SPDT relay in an eight-pin socket intended for use with one of the eight-pin relays. This would not damage the instrument or the relay, but would cause a malfunction of the instrument. The eight-pin DPDT relays may be placed in their sockets facing either direction, as these relays are symmetrical. The eight-pin DPAT relay is not symmetrical and must be placed in the socket with the Tektronix Part Number facing toward the top of the instrument.

Transistor Replacement. Transistors should not be replaced unless actually defective. If removed from their sockets during routine maintenance, return them to their original sockets. Unnecessary replacement of transistors may affect the calibration of this instrument. When transistors are replaced, check the operation of that part of the instrument which may be affected.

Replacement transistors should be of the original type or a direct replacement. Remount the transistors in the same manner as the original. Fig. 4-4 shows the lead configurations of the transistors used in this instrument. This view is as seen from the bottom of the transistor. When replacing transistors, check the manufacturer's basing diagram for correct basing.

Light-Bulb Replacement. The POLARITY, BANDWIDTH, and Input Coupling switches each contain one incandescent light bulb common to the two or three push-buttons of the switch. This light bulb may be replaced without removal of the switch as follows:

1. Remove the screw and cover from the back of the switch, exposing the light bulb.

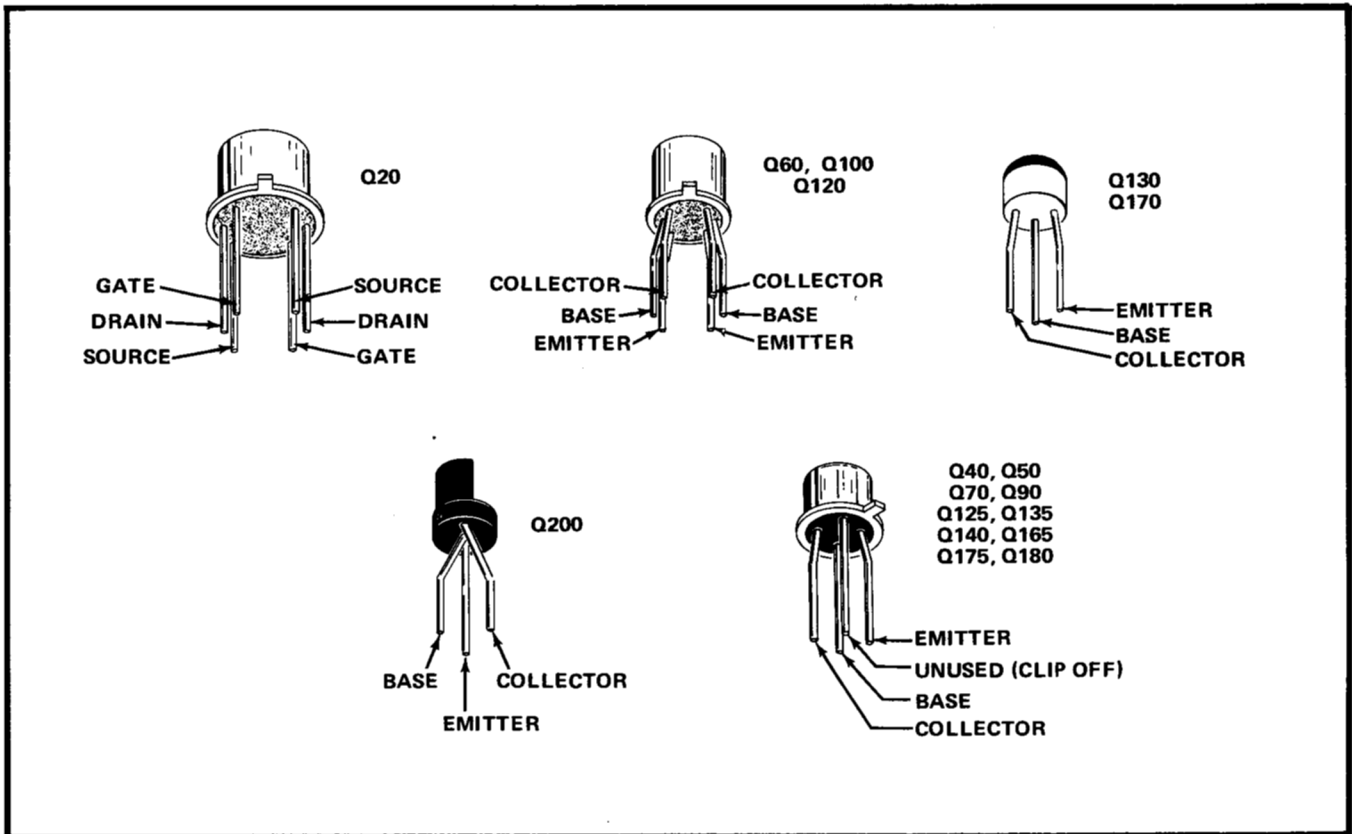

Fig. 4-4. Electrode configuration for transistors in this instrument.

2. While holding one lead of the bulb with a pair of long-nosed pliers, touch a 15-watt pencil-type soldering iron to the connection on the other side of the circuit board. Remove the lead from the circuit board. Unsolder the remaining lead and remove the bulb.

3. Cut the leads of the replacement bulb to the same length as those of the old bulb.

4. Grasp one lead of the replacement bulb with the long-nosed plier and position in one of the appropriate holes in the circuit board. Touch the soldering iron to the connection on the other side of the circuit board and push the lead into place. Repeat with the remaining lead.

5. Position the bulb so that it does not fall in line with the bottom pushbutton. Replace the cover.

POLARITY BANDWIDTH, or Input Coupling Switch Replacement. Should one of the pushbutton switches fail, the front panel must be removed to gain access to the switch mounting screws. Proceed as follows:

1. Remove the four control knobs from their shafts. The IDENTIFY button pulls off; use a $\frac{1}{16}$ -inch hex-head wrench to remove the POSITION, VOLTS/DIV, and VAR control knobs.

2. Remove the front panel to gain access to the switch mounting screws.

3. Remove the screw holding the faulty switch assembly.

4. Remove the connections on the circuit board.

5. Install the replacement switch by reversing the above procedure.

VOLTS/DIV Switch Strip Replacement. The VOLTS/DIV switch contains ten strips which are individually adjusted for optimum input response in each position of the switch. These strips should not be removed unless they are known to be defective, in which case replacements can be obtained from your local Tektronix Field Office or representative. To replace a defective strip, proceed as follows:

1. Remove the attenuator cover.

2. Rotate the VOLTS/DIV control to position the defective strip to the right side of the instrument.

3. Move the strip about one-quarter inch toward the rear of the switch. Lift the strip out of the switch assembly.

4. Replace the defective strip with the new part. (Refer to the Electrical Parts List for replacement information.)

CAUTION

When replacing a VOLTS/DIV switch strip, carefully align the guides on the edges of the strip with the grooves in the switch assembly, then slide the strip into place.

Maintenance—Type 7A16

5. Adjust the new strip(s) for optimum response as described in Section 5.

Main Circuit Board Replacement. If the main amplifier circuit board requires replacement, a complete wired board is available from Tektronix, Inc. To replace the circuit board, proceed as follows:

1. The GAIN potentiometer is driven from the front panel by a control shaft. Using a .05-inch hex-head wrench, loosen the two set screws on the front portion of the coupling and remove the shaft.

2. Disconnect the VARIABLE control shaft from the push switch and potentiometer.

3. Remove the two screws which secure the circuit board to the VOLTS/DIV switch housing.

4. Unsolder R14-C14 (connected from the VOLTS/DIV switch to the tie point at the front of the circuit board) from the VOLTS/DIV switch.

5. Remove all the pin connections on the left side of the main circuit board.

6. Unsolder the four leads from the VARIABLE switch (cal/uncal switch) circuit board.

7. Remove the four screws which secure the rear casting to the top and bottom frames.

8. Remove the screws on the six mounting clamps along the top and bottom edges of the circuit board.

9. Remove the circuit board assembly from the instrument.

10. Lift the top and bottom tabs which hold the rear casting to the circuit board and remove.

11. Unsolder the VARIABLE and GAIN potentiometer connections and remove the mounting brackets from the circuit board.

12. Install the replacement circuit board by reversing the above procedure. The wiring color-codes for the pin connections are shown in Fig. 4-5.

Recalibration After Repair

After any electrical component has been replaced, the calibration of that particular circuit should be checked, as well as the calibration of other closely related circuits. The Performance Check procedure in Section 5 provides a quick and convenient means of checking instrument operation.

Circuit Board Square Pin Replacement. If the circuit board pins are damaged or broken a field replacement kit (Tektronix Part Number 040-0542-00), containing the necessary parts and a replacement instruction sheet, can be obtained from Tektronix, Inc. To replace a pin proceed as follows:

1. Remove the broken pin by applying heat to the pin while maintaining a steady pull on the pin. Do not use excessive heat as this may separate the pin ferrule from the circuit board laminate.

2. Remove and discard the ferrule from the new pin.

3. Position the new pin in place and carefully solder the pin to both sides of the circuit board. Do not use excessive heat.

4. For those pins that have been formed, use pliers to bend to appropriate configuration after installation.

End Lead Pin Connector Replacement. The pin connectors used to connect the wires to the circuit board pins are clamped to the ends of the associated leads. To replace the pin connectors proceed as follows:

1. Clip off the damaged pin connector and dress the lead for the new connector.

2. Clamp the new pin connector to the lead.

Some of the pin connectors are grouped together and mounted in a plastic holder. To remove the pin connector from the plastic holder, lift up on the back end and pull out. To provide correct orientation of this multi connector when it is replaced, an arrow is stamped on the circuit board and a matching arrow is molded into the plastic housing of the multi pin connector.

Instrument Repackaging

If the Type 7A16 is to be shipped for long distances by commercial means of transportation, it is recommended that the instrument be repackaged in the original manner for maximum protection. The original shipping carton can be saved and used for this purpose. Repackaging information and/or new shipping cartons can be obtained from Tektronix, Inc. Contact your local Tektronix Field Office or representative.

NOTE

The plug-ins should not be shipped installed in an oscilloscope. The oscilloscope packaging material is not designed to protect the plug-ins.

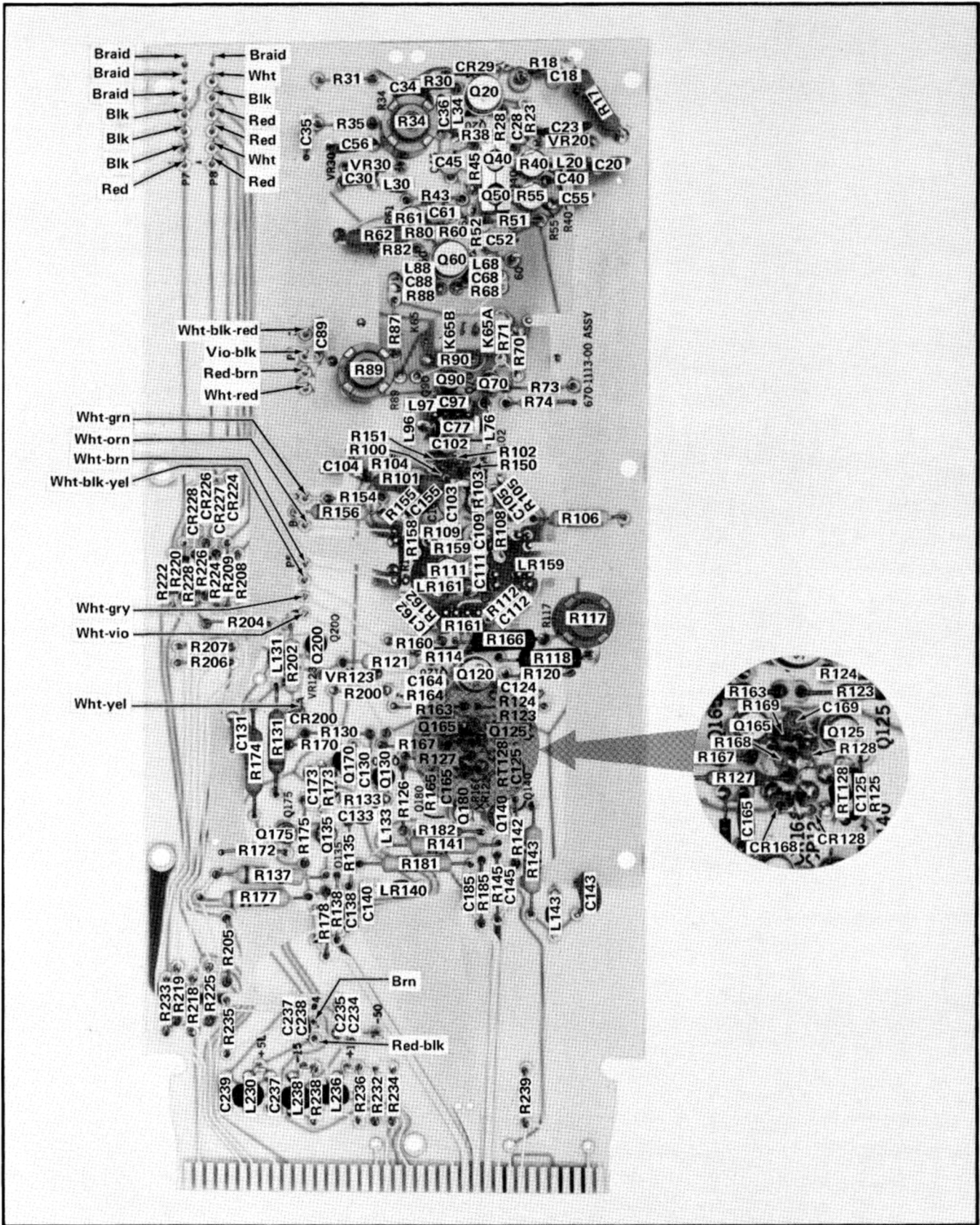

Fig. 4-5. Main amplifier circuit board (front).

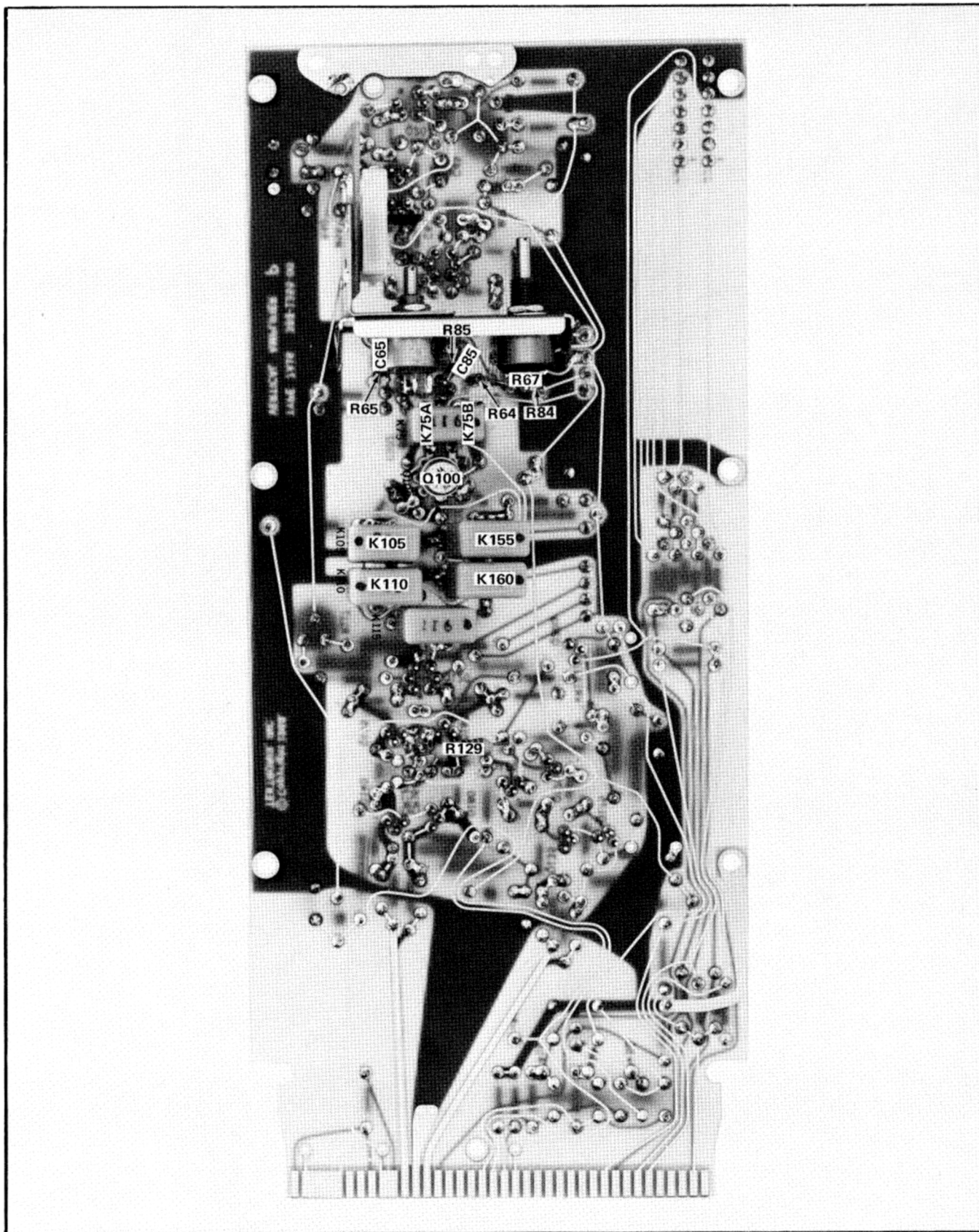

Fig. 4-6. Main amplifier circuit board (rear).

SECTION 5

PERFORMANCE CHECK / CALIBRATION

Change information, if any, affecting this section will be found at the rear of the manual.

INTRODUCTION

To assure instrument accuracy, check the calibration of the 7A16 every 1000 hours of operation, or every six months if used infrequently. Before complete calibration, thoroughly clean and inspect this instrument as outlined in the Maintenance section.

As an aid to the calibration of the instrument, a Short-Form Procedure is given prior to the complete procedure. To facilitate instrument calibration for the experienced calibrator, the Short-Form Procedure lists the calibration adjustments necessary for each step and the applicable tolerances. This procedure also includes the step number and title as listed in the complete Performance Check/Calibration Procedure and the page number on which each step begins. Therefore, the Short-Form Procedure can be used as an index to locate a step in the complete procedure. Another feature of the Short-Form Procedure is the spaces provided to record performance data or to check off steps as they are completed. This procedure can be reproduced and used as a permanent record of instrument calibration.

The complete Performance Check/Calibration Procedure can be used to check instrument performance without removing the covers or making internal adjustments by performing all portions except the ADJUST part of a step. Screwdriver adjustments accessible without removing the covers are adjusted as part of the performance check procedure. A note titled PERFORMANCE CHECK ONLY gives instructions which are applicable only to the performance check procedure and if necessary, lists the next applicable step for the performance check procedure.

Completion of each step in the complete Performance Check/Calibration Procedure insures that this instrument meets the electrical specifications given in Section 1. Where possible, instrument performance is checked before an adjustment is made. For best overall instrument performance when performing a complete calibration procedure, make each adjustment to the exact setting even if the CHECK is within the allowable tolerance.

NOTE

Limits, tolerances and waveforms in this procedure are given as calibration guides and should not be interpreted as instrument specifications except as specified in Section 1. All waveforms shown in this procedure were taken with a Tektronix Oscilloscope Camera System.

A partial calibration is often desirable after replacing components, or to touch up the adjustment of a portion of the instrument between major recalibrations. To check or adjust only part of the instrument, set the controls as given under Preliminary Control Settings and start with the nearest test equipment picture preceding the desired portion. If any controls need to be changed from the preliminary settings for this portion of the calibration procedure, they are listed under the heading Partial Procedure following the equipment required picture. To prevent unnecessary recalibration of other parts of the instrument, readjust only if the tolerance given in the CHECK part of the step is not met. If readjustment is necessary, also check the calibration of any steps listed in the INTERACTION part of the step.

TEST EQUIPMENT REQUIRED

General

The following test equipment and accessories, or its equivalent, are required for complete calibration of the Type 7A16. Specifications given are the minimum necessary for accurate calibration. Some of the recommended equipment may have specifications which exceed those given. All test equipment is assumed to be correctly calibrated and operating within the given specifications. If equipment is substituted, it must meet or exceed the specifications of the recommended equipment.

Test Equipment

1. 7000 series Indicator Oscilloscope. Type 7704 used in these checks.
2. 7B—series Time-Base. Type 7B71 used in these checks.
3. Test Oscilloscope. Storage and Sampling capabilities; bandwidth, at least 1000 megahertz; minimum deflection factor, 50 millivolts/div. Tektronix Type 564B with 3S1/3T2 plug-in units recommended.
4. Pulse Generator. Risetime, 0.25 nanosecond; amplitude, 0 to 50 volts into 50 ohms. Tektronix Type 109 recommended.
5. Delay Line. Characteristic impedance, 50 ohms; 60 nanoseconds delay. Tektronix Type 113 Delay Cable recommended.

Performance Check/Calibration—Type 7A16

6. Constant Amplitude Sine-Wave Generator. Reference frequency, 50 kHz; frequency range, below 15 megahertz to above 60 megahertz; output amplitude, variable from 0.5 to 5 volts peak to peak; amplitude accuracy, within 3% of 50 kHz reference as output frequency changes. Tektronix Type 191 Constant Amplitude Signal Generator recommended.

7. Type 106 Square Wave Generator. Risetime, 1 nanosecond into 50 ohms; amplitude, 50 mV to 500 mV; frequency, 1 kHz.

8. Constant Amplitude Signal Generator. Repetition rate, about 1 kHz; voltage range, 25 millivolts to 25 volts; accuracy, $\pm 0.25\%$. Tektronix Standard Amplitude Calibrator 067-0502-00 recommended.

9. DC Voltmeter. 20,000 ohms/volt minimum sensitivity; range, 0 to 50 volts; accuracy, checked to within 1% at the voltages to be measured. For example, Triplett Model 630-NA.

10. Calibration Fixture, Constant Amplitude Signal Generator. Reference frequency, 3 megahertz; frequency range, 65 megahertz to above 175 megahertz; output amplitude, 0.5 to 5 volts peak to peak into 50 ohms; amplitude accuracy, output amplitude constant within 1% of 3 megahertz reference as output frequency changes. Tektronix Part Number 067-0532-00.

11. Calibration Fixture, Plug-In Extender. Tektronix Part Number 067-0589-00.

12. Pulse Generator. Risetime, 70 picoseconds; amplitude, 200 mV into 50 ohms; pulse width, 1 microsecond. Tektronix Type 284 recommended.

Accessories

13. Cable (two). Impedance, 50 ohms; electrical length, 2 nanoseconds; connectors, GR. Tektronix Part Number 017-0505-00.

14. Adapter (two). GR to BNC female. Tektronix Part Number 017-0063-00.

15. Adapter. GR to BNC male. Tektronix Part Number 017-0064-00.

16. Adapter (two). GR elbow. Tektronix Part Number 017-0070-00.

17. Termination. Impedance, 50 ohms; endline; connector, GR. Tektronix Part Number 017-0081-00.

18. 50 ohm Feedthrough Termination. Tektronix Part Number 011-0049-01 (2 each).

19. 10 \times Attenuator, BNC connectors. Tektronix Part Number 011-0059-01, (2 each).

20. 15 pF RC Normalizer, BNC connectors. Tektronix Part Number 067-0537-00.

21. Coaxial Cable; electrical length, 5 nanoseconds; GR connectors. Tektronix Part Number 017-0512-00.

22. CT-3 Signal Pickoff. Tektronix Part Number 017-0061-00.

23. Coaxial Cable. Impedance, 50 ohms; length, 42 inches; connectors, BNC. Tektronix Part Number 012-0057-01.

SHORT FORM PROCEDURE

Type 7A16

Calibration Date _____

Calibrated By _____

- 1. Adjust DC Balance (R34) Page 5-4
Requirement: Adjusted for zero volts from TP60 to ground.
Performance: Correct _____; Incorrect _____.
- 2. Check/Adjust Variable Balance (R89) Page 5-4
Requirement: 0.5 div or less of trace shift as VARIABLE is rotated.
Performance: Correct _____; Incorrect _____.
- 3. Check Step Attenuator Range Page 5-4
Requirement: At least 10 divisions at 5 mV/div.
Performance: Correct _____; Incorrect _____.
- 4. Check/Adjust Step Attenuator Balance Page 5-4
(R153)
Requirement: Trace shift of 0.5 division or less as VOLTS/DIV is changed from one setting to the next.
Performance: Correct _____; Incorrect _____.
- 5. Adjust Position Centering (R117) Page 5-5
Requirement: No potential difference between the output lines (A11 and B11) when the trace is positioned to graticule center.
Performance: Correct _____; Incorrect _____.
- 6. Check Position Range Page 5-5
Requirement: ± 10 divisions from graticule center.
Performance: Correct _____; Incorrect _____.
- 7. Check +UP to Invert Shift Page 5-5
Requirement: One division or less trace shift when switching from +UP to INVERT.
Performance: Correct _____; Incorrect _____.
- 8. Check/Adjust Front Panel Gain (R66) Page 5-5
Requirement: With the VOLTS/DIV at 10 mV and a 50 mV signal applied, the display can be adjusted to five divisions.
Performance: Correct _____; Incorrect _____.
- 9. Check Variable Control Range Page 5-6
Requirement: Continuously variable between calibrated VOLTS/DIV settings (2.5:1 ratio).
Performance: Correct _____; Incorrect _____.

- 10. Check Trigger DC Level Page 5-6
Requirement: Within one division of signal DC level.
Performance: Correct _____; Incorrect _____.
- 11. Check Trigger Gain Page 5-6
Requirement: Within 10% of signal gain.
Performance: Correct _____; Incorrect _____.
- 12. Check Volts/Div Deflection Accuracy Page 5-6
Requirement: Vertical deflection factor within 2% of VOLTS/DIV switch indication with gain adjusted at 10 mV/Div.
Performance: Correct _____; Incorrect _____.
- 13. Adjust Input Compensation (C18) Page 5-7
Requirement: Optimum square wave response.
Performance: Correct _____; Incorrect _____.
- 14. Adjust Volts/Div Compensation (C6A, C6B, C7A, C7B, C8A, C8B, C9A, C9B, C10A, C10B, C11A, C11B, C12A, C12B) Page 5-7
Requirement: Optimum square corner and flat top.
Performance: Correct _____; Incorrect _____.
- 15. Adjust High Frequency Compensation, 5 mV (R40, R55, C61, C102, C52, C45, C103, R103, R61) Page 5-8
Requirement: Best square corner and level with aberrations not to exceed 6% P-P.
Performance: Correct _____; Incorrect _____.
- 16. Adjust High Frequency Compensation, 10 mV (R111, C111) Page 5-8
Requirement: Best square corner and level with aberrations not to exceed 6% P-P.
Performance: Correct _____; Incorrect _____.
- 17. Adjust High Frequency Compensation, 20 mV (R109, C109) Page 5-8
Requirement: Best square corner and level with aberrations not to exceed 6% P-P.
Performance: Correct _____; Incorrect _____.
- 18. Check Step Response Page 5-9
Requirement: Risetime not to exceed 1.4 nanoseconds and aberrations not to exceed 6% P-P at 5 mV/div to .5 V/div or 8% P-P at 1 V/div to 5 V/div.
Performance: Correct _____; Incorrect _____.
- 19. Check Upper Bandwidth —3 dB Point Page 5-9
Requirement: Not more than —3 dB at 250 megahertz.
Performance: Correct _____; Incorrect _____.

- 20. Check Trigger Step Response Page 5-10
Requirement: Risetime not to exceed 2.1 nanoseconds and aberrations not to exceed 15% P-P.
Performance: Correct _____; Incorrect _____.
- 21. Check 20 Megahertz Bandwidth Limiting Page 5-11
Requirement: —3 dB at 20 megahertz within 3 megahertz.
Performance: Correct _____; Incorrect _____.
- 22. Check Overall Noise Level Tangentially Page 5-11
Requirement: 0.1 division or less at 5 mV/division.
Performance: Correct _____; Incorrect _____.

PERFORMANCE CHECK/CALIBRATION PROCEDURE

General

The following procedure is arranged so the Type 7A16 can be calibrated with the least interaction of adjustments and reconnection of equipment. A picture of the test equipment required for each group of steps is given to aid in identification of the necessary equipment. The control settings and test equipment setup throughout this procedure continue from the preceding step(s) unless noted otherwise. The control settings can be checked at any "test equipment required" picture by setting the controls as given at the start of the procedure under the heading Preliminary Control Settings. Then make any changes listed following the test equipment required picture, under the heading Partial Procedure (also applies to partial calibration procedure).

The following procedure uses the equipment listed under Test Equipment Required. If other equipment is substituted, control settings or calibration setup may need to be altered to meet the requirements of the equipment used. Detailed operating instructions for the test equipment are not given in this procedure. Refer to the instruction manual for the test equipment if more information is required.

NOTE

This instrument should be calibrated at an ambient temperature of +20°C to +30°C for best overall accuracy. The performance of this instrument can be checked at any temperature within the 0°C to +50°C range. If the temperature is outside the given range, see Section 1 for the applicable tolerances.

Preliminary Procedure for Complete Calibration

1. Connect the Type 7A16 to the plug-in extender.
2. Insert the plug-in extender in the oscilloscope right vertical compartment.
3. Insert the time base in the oscilloscope left (A) horizontal compartment.

Performance Check/Calibration—Type 7A16

4. Connect the oscilloscope to a suitable power source.
5. Set the controls as given under Preliminary Control Settings.
6. Turn the oscilloscope power switch to on and allow 20 minutes warmup before proceeding with calibration of the instrument.

Preliminary Control Settings

Type 7A16

POSITION	Midrange
POLARITY	+UP
BANDWIDTH	FULL
COUPLING	GND
VOLTS/DIV	5 mV
VARIABLE	CAL IN

Type 7B71

Level/Slope	0/+
Triggering	
Mode	P-P Auto
Coupling	AC
Source	Int
Magnifier	×1
Time/Div	0.5 ms
Variable	Cal In
B Delay Mode	Independent

Type 7704

Intensity	ccw
Calibrator	
Rate	1 kHz
Volts	40 mV
Vertical Mode	Right
Horizontal Mode	A
A Trigger Source	Right Vertical

Type 564B

Intensity	Optimum
Upper Screen	Store
Lower Screen	Store

Type 3T2

Time Position	
(Fine and Coarse)	Fully cw
Horiz Position	Midrange

Range	100 ns
Start Point	With Trigger
Time Magnifier	×1
Display Mode	Normal
Polarity	+
Source	Int

Type 3S1

Position (A and B)	Midrange
Dual Trace	A + B
mVOLTS/Div (both)	50
CH 1 Invert/Norm	Norm
CH 2 Invert/Norm	Invert
Internal Trigger	A

1. Adjust DC Balance (R34)

- a. Set the controls as given under Preliminary Control Settings.
- b. Connect the voltmeter between TP 60 and ground.
- c. ADJUST—R34 for zero volts from TP 60 to ground.

2. Check/Adjust Variable Balance (R89)

- a. Press and release the VARIABLE control to its outward position.
- b. CHECK—For 0.5 div or less of trace shift as the VARIABLE control is rotated throughout its range.
- c. ADJUST—R89 for minimum movement of trace as VARIABLE control is rotated.

3. Check Step Attenuator Range

- a. Turn STEP ATTEN BAL adjustment fully clockwise and position the trace to graticule center with the POSITION control.
- b. Connect a 50 mV square wave from the standard amplitude calibrator to the Type 7A16 INPUT.
- c. CHECK—Set the COUPLING switch to DC and turn the STEP ATTEN BAL adjustment fully counterclockwise. Check that the top of the square wave is at or below graticule center.
- d. Set the STEP ATTEN BAL adjustment to midrange.

4. Check/Adjust STEP ATTENUATOR BAL (R153)

- a. Set the COUPLING switch to GND and center the trace on the CRT with the POSITION control.

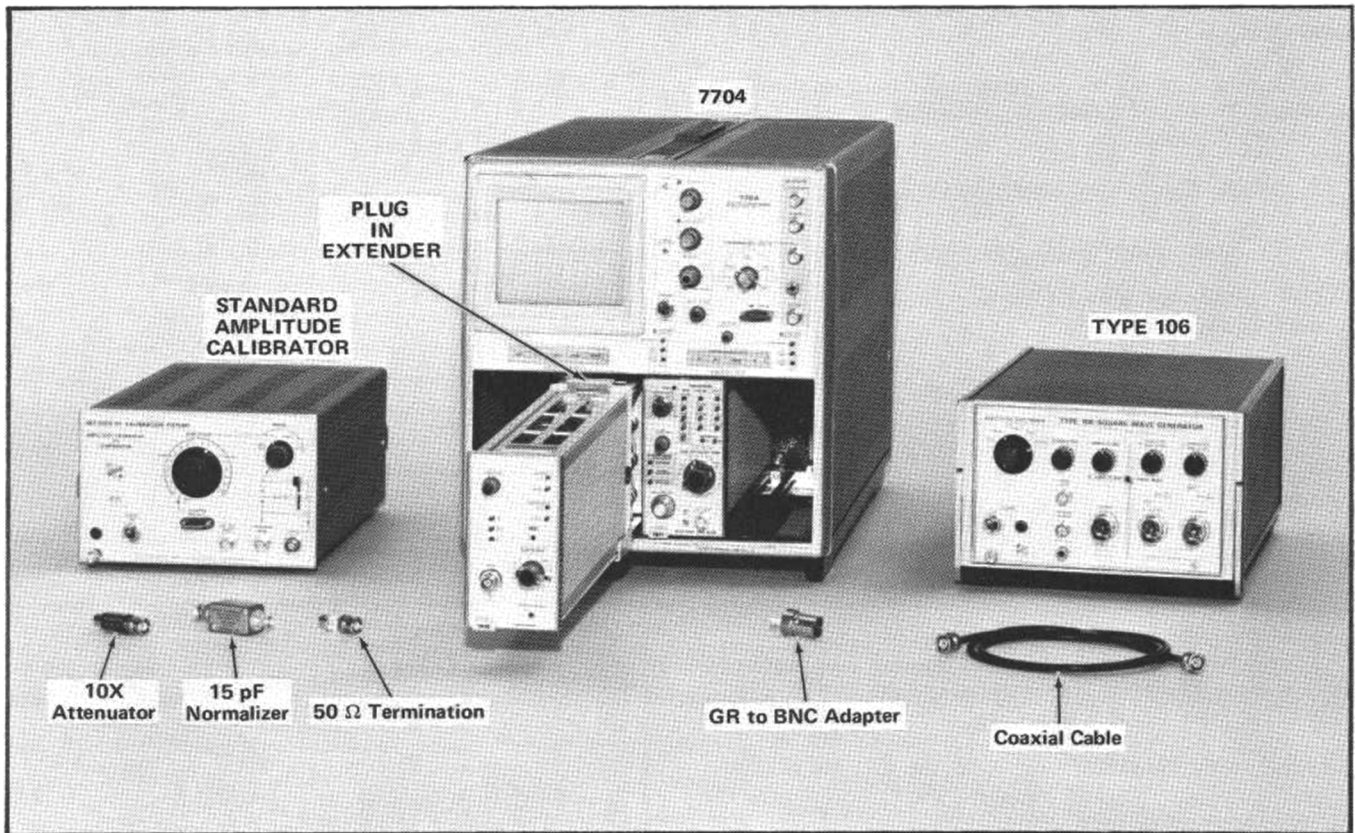

Fig. 5-1. Test equipment required for steps 8 through 12.

PERFORMANCE CHECK

This adjustment may be performed as part of the Performance Check.

- b. ADJUST—STEP ATEN BAL (a front-panel adjustment) for minimum trace shift as the VOLTS/DIV is changed from 5 mV to 20 mV.
- c. CHECK—The remaining positions of the VOLTS/DIV switch for no trace shift between steps.

5. Adjust Position Centering (R117)

- a. Center the trace on the CRT with the POSITION control.
- b. Connect the voltmeter between A11 and B11 (the rearward end of R185 and R145).
- c. ADJUST—R117 for a null (zero) reading on the voltmeter.

6. Check Position Range

- a. Set the input COUPLING to AC, VOLTS/DIV to 20 mV and center the trace with the POSITION control.

- b. Set the oscilloscope calibrator to 40 mV and connect a BNC cable from the calibrator output to the Type 7A16 INPUT.

- c. Center the display on the CRT with the POSITION control.

- d. Reset the oscilloscope calibrator to 0.4 V and turn the POSITION control fully clockwise.

- e. CHECK—The bottom of the waveform must position to graticule center or above. Turn the POSITION control fully counterclockwise and check that the top of the waveform can be positioned to graticule center or below.

- f. Disconnect the signal from the Type 7A16 INPUT.

7. Check + UP to INVERT shift

- a. Set the VOLTS/DIV to 5 mV.
- b. CHECK—Press the INVERT button and check for 1 division or less of trace movement.

8. Check/Adjust Front Panel GAIN (R66)

- a. Test Equipment is shown in Fig. 5-1.

Performance Check/Calibration—Type 7A16

b. Set the VOLTS/DIV to 10 mV, POLARITY to + UP and COUPLING to DC.

c. Connect a 50 mV square wave signal from the standard amplitude calibrator through a coaxial cable to the Type 7A16 INPUT connector.

d. CHECK—The vertical amplitude for exactly 5 divisions.

PERFORMANCE CHECK

This adjustment may be performed as part of the performance check.

e. ADJUST—GAIN (a front panel adjustment) for exactly 5 divisions of vertical amplitude.

9. Check VARIABLE Control Range

a. With the standard amplitude calibrator connected as above, press and release the VARIABLE control to its outward position.

b. CHECK—Rotate the VARIABLE control fully counterclockwise and check for 2 divisions or less off vertical amplitude (2.5:1 ratio requirement).

c. Return the VARIABLE control to the CAL IN position.

10. Check Trigger DC Level

a. Set the Type 7A16 COUPLING switch to GND and position the trace to graticule center with the POSITION control.

b. Connect the extender trigger cables to the signal jacks and terminate the signal cables into 50 ohms.

c. CHECK—The trace must be within one division of graticule center.

11. Check Trigger Gain

a. Reset the COUPLING switch to AC and VOLTS/DIV to 10 mV.

b. Connect a 50 mV square wave from the standard amplitude calibrator to the Type 7A16 INPUT.

c. CHECK—For a display amplitude of five divisions ± 0.5 division.

d. Return the extender trigger and signal cables to their correct jacks.

12. Check VOLTS/DIV Deflection accuracy

a. CHECK—Using Table 5-1 as a guide, check the vertical deflection factor from 5 volts to 5 millivolts.

b. Disconnect the standard amplitude calibrator.

TABLE 5-1
Deflection Factor Accuracy Check

VOLTS/DIV Switch Setting	Standard Amplitude Calibrator Output Amplitude	Divisions of Deflection	Accuracy
5 V	20 V	4	$\pm 2\%$
2 V	10 V	5	$\pm 2\%$
1 V	5 V	5	$\pm 2\%$
.5 V	2 V	4	$\pm 2\%$
.2 V	1 V	5	$\pm 2\%$
.1 V	.5 V	5	$\pm 2\%$
50 mV	.2 V	4	$\pm 2\%$
20 mV	.1 V	5	$\pm 2\%$
10 mV	50 mV	5	$\pm 2\%$
5 mV	20 mV	4	$\pm 2\%$

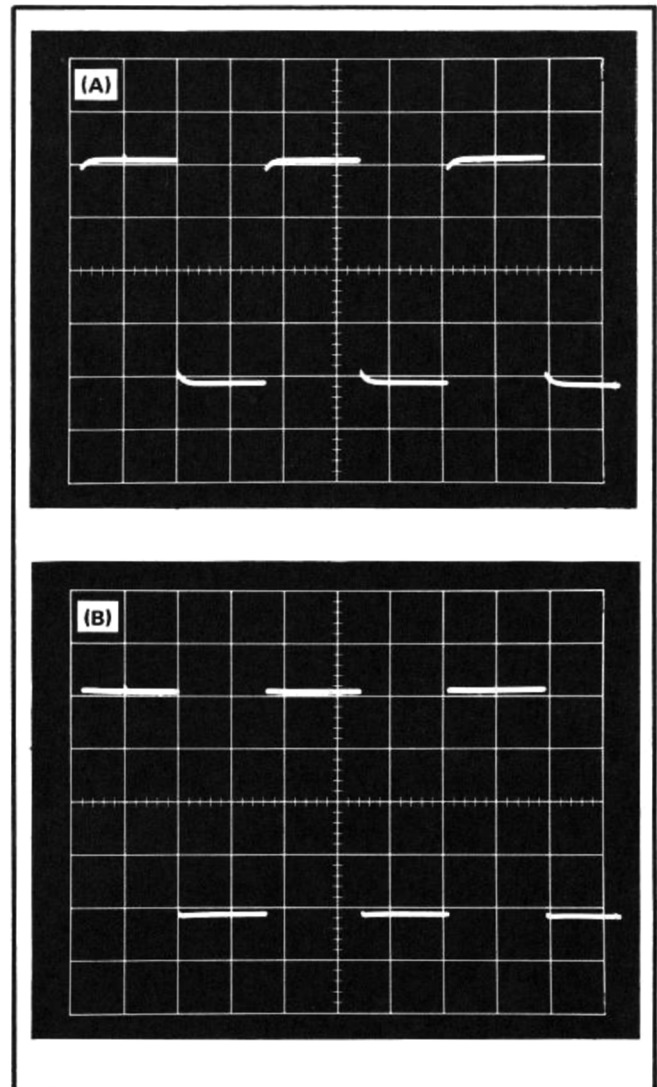

Fig. 5-2. (A) Compensation incorrectly set. (B) Input properly compensated.

13. Adjust Input Compensation (C18)

- a. Reset the Type 7A16 VOLTS/DIV to 5 mV and the time-base Time/Div to .1 ms.
- b. Connect a 3 kHz square wave from the Type 106 high-amplitude output through a GR to BNC adapter, coaxial cable, 10× attenuator, 50 ohm feedthrough termination and 15 pF input RC normalizer to the Type 7A16 INPUT connector. Adjust the Type 106 amplitude for about four divisions of display.
- c. ADJUST—C18 for best square leading corner (no overshoot or rolloff, see Fig. 5-2A and B).
- d. Switch the COUPLING to AC and check that the display shifts up about two divisions. Return the COUPLING switch to DC.

14. Adjust Volts/Division Series and Shunt Compensation

- a. Using Table 5-2 as a guide, check the CRT display at each VOLT/DIV setting and adjust for best square leading corner and flat top on the display. Adjust the Type 106 amplitude as necessary to maintain a four division display for each VOLTS/DIV setting.

TABLE 5-2**Series and Shunt Compensations**

VOLTS/DIV Switch Setting	Adjust For Best Flat Top	Adjust For Best Square Corner
50 mV	C6A	C6B
.1 V	C7A	C7B
.2 V	C8A	C8B
.5 V	C9A	C9B
1 V	C10A	C10B
2 V	C11A	C11B
5 V	C12A	C12B

- b. Disconnect the Type 106 square wave generator.

Partial Procedure

If beginning a partial procedure with this step, set the controls as given under Preliminary Control Settings, except set the Type 7A16 Input Coupling to DC.

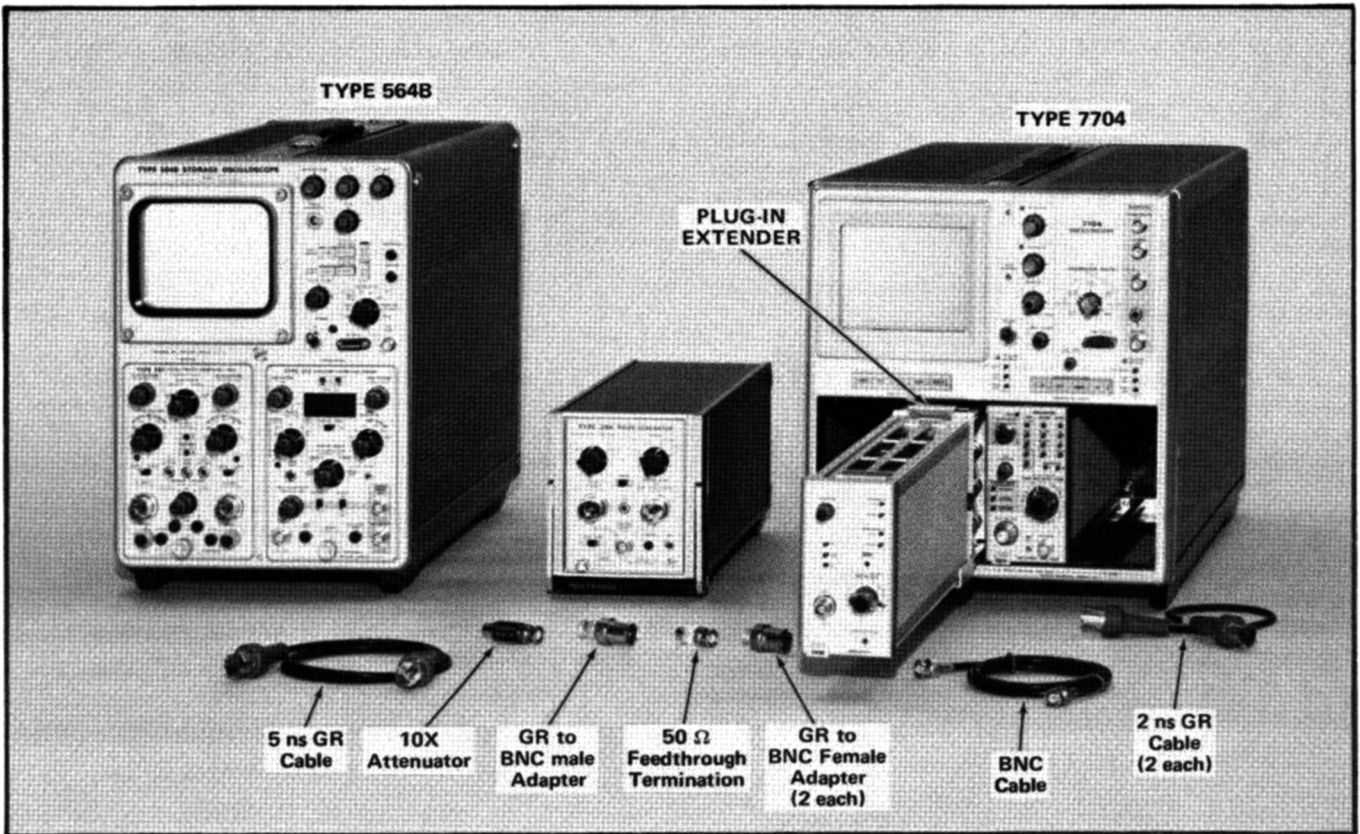

Fig. 5-3. Test equipment required for steps 15, 16 and 17.

15. Adjust High Frequency Compensation (5 mV)

- a. Test equipment required is shown in Fig. 5-3.
- b. Set the Type 7A16 VOLTS/DIV to 5 mV.
- c. Connect the plug-in extender left signal cable (A11) through a 2 nanosecond cable to the Type 3S1 channel A input; connect the right signal cable (B11) through a 2 nanosecond cable to the Type 3S1 channel B input; connect the Type 284 pulse output through a 5 nanosecond cable, GR to BNC adapter, 10× attenuator and 50 ohm feedthrough termination to the Type 7A16 INPUT; connect the Type 284 trigger output through a BNC cable to the Type 3T2 50 ohm trigger input.

d. ADJUST—According to the information given below for best overall response (compromise between best risetime and least aberrations):

Adjustment	Adjust For
R40 - R55	Least Ringing
C61 - C102	Best Front Corner
C52	Best Level
C45	Best Front Corner
C103 - R103	Best Level
R61	Best Level

INTERACTION: Perform steps 16 and 17.

16. Adjust High Frequency Compensation (10 mV)

- a. Equipment setup as in step 15 except Type 7A16 VOLTS/DIV to 10 mV.
- b. ADJUST—R111 for minimum ringing and C111 for best front corner.

INTERACTION: Perform steps 15 and 17.

17. Adjust High Frequency Compensation (20 mV)

- a. Equipment setup as in step 15 except, Type 7A16 VOLTS/DIV to 20 mV.
 - b. ADJUST—R109 and C109 for best front corner and best level.
- INTERACTION: Repeat steps 15, 16 and 17 until optimum results are obtained.

c. Remove the Type 7A16 from the plug-in extender and insert the Type 7A16 into the Type 7704 vertical compartment.

d. Repeat steps 15, 16 and 17 touching up adjustments as necessary to obtain the best front corner and level.

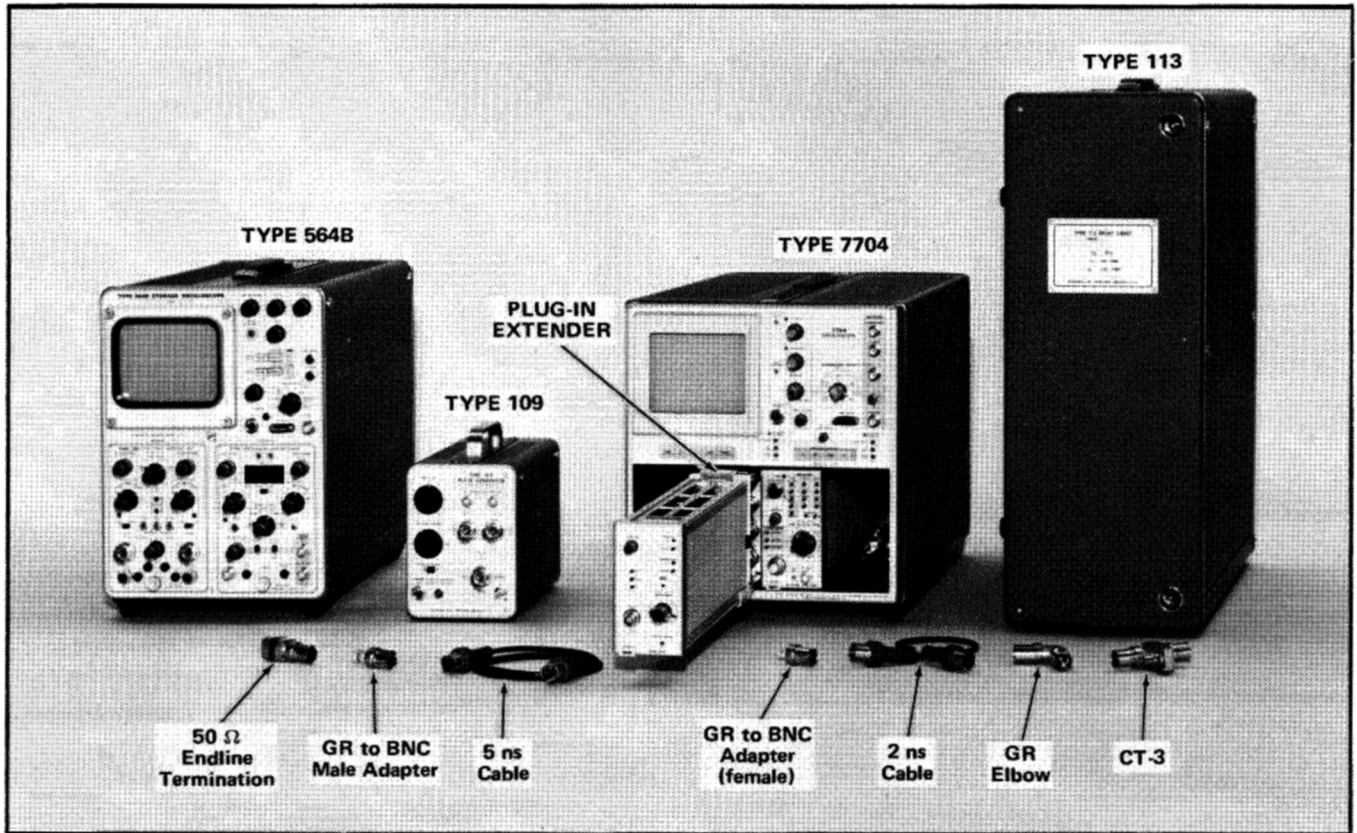

Fig. 5-4. Test equipment required for steps 18 and 20.

e. Reconnect the Type 7A16 to the plug-in extender. Check the sampling display to ensure that no ringing has been introduced.

Partial Procedure

If beginning a partial procedure with this step, set the controls as given under Preliminary Control Settings, except set Type 7A16 Input Coupling to DC.

18. Check Step Response

- a. Test equipment required is shown in Fig. 5-4.
- b. Connect the Type 109 charge line through two GR elbows to the Type 113 delay cable; terminate the other charge line with a 50 ohm GR end-line termination; connect the Type 109 output through the CT-3 pickoff, 5 nano-second cable, 50 ohm feedthrough termination to the Type 7A16 INPUT; connect a BNC cable from the CT-3 BNC connector to the 3T2 50 ohm trigger input; using two 2 nano-second cables, connect the plug-in extender left signal cable (A11) to the Type 3S1 channel A input and the extender right signal cable (B11) to the channel B input.

c. CHECK—All positions of the VOLTS/DIV switch for risetime and aberrations (see Fig. 5-5) using the information given in Table 5-3.

TABLE 5-3
Step Response Adjustments

VOLTS/DIV Setting	Risetime	Aberrations (maximum)	Type 109
5 mV/Div to 20 mV/Div	1.4 ns	+3%, -3%; total of 6% P-P	Adjusted for five divisions of display for all settings of VOLTS/DIV switch
50 mV/Div to 0.5 V/Div	1.4 ns	+4%, -4%; total of 6% P-P	
1 V/Div to 5 V/Div	1.4 ns	+5%, -5%; total of 8% P-P	

NOTE

The risetime and aberrations given in Table 5-3 are for calibration aids only and are not instrument specifications.

19. Check Upper Bandwidth —3 dB Point

- a. Set the VOLTS/DIV to 10 mV and COUPLING to DC.
- b. Connect the constant amplitude generator 067-0532-00 through a GR to BNC adapter, 10× attenuator and 50 ohm feedthrough termination to the Type 7A16 INPUT.
- c. Set generator frequency to 3 MHz and adjust the amplitude for a six division display on the sampling oscilloscope.

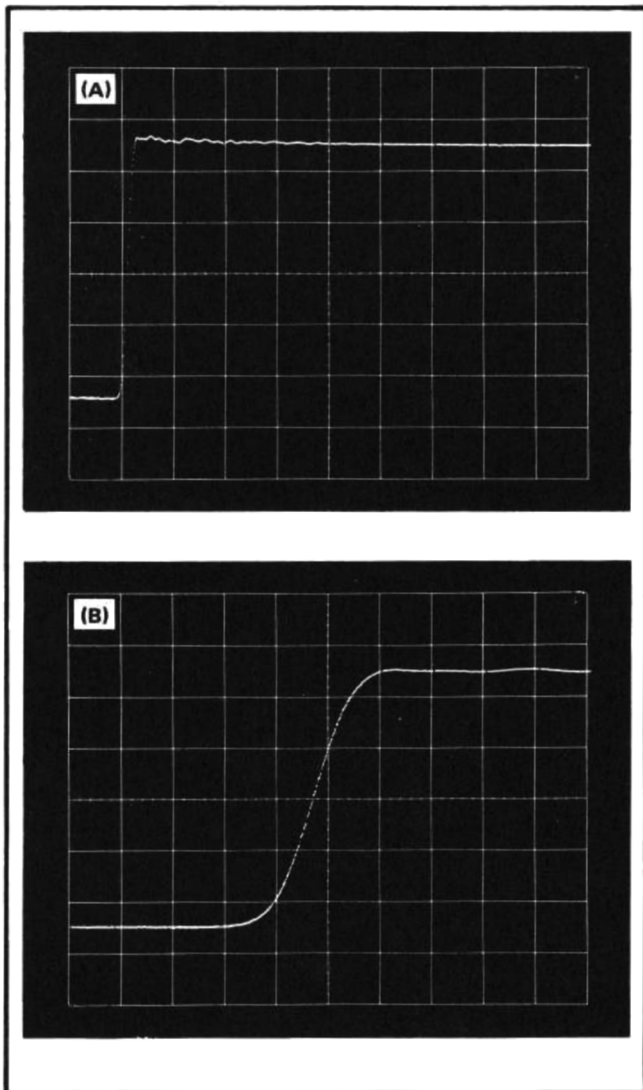

Fig. 5-5. CRT display showing (A) typical aberrations and (B) typical risetime of the Type 7A16.

d. CHECK—Increase the generator frequency until the display decreases to 4.2 divisions and check that the frequency of the signal generator is 250 MHz or greater.

NOTE

This bandwidth limit is given as an aid to calibration and is not an instrument specification.

e. Return the extender signal cables to their correct jacks and reset the generator to 3 MHz.

f. Adjust the generator amplitude for a six division display on the Type 7704 oscilloscope .

g. CHECK—Increase the generator frequency until the display decreases to 4.2 divisions and check that the frequency of the generator is 150 MHz or greater (if a Type 7504 oscilloscope is used, check that the frequency is 90 MHz or greater).

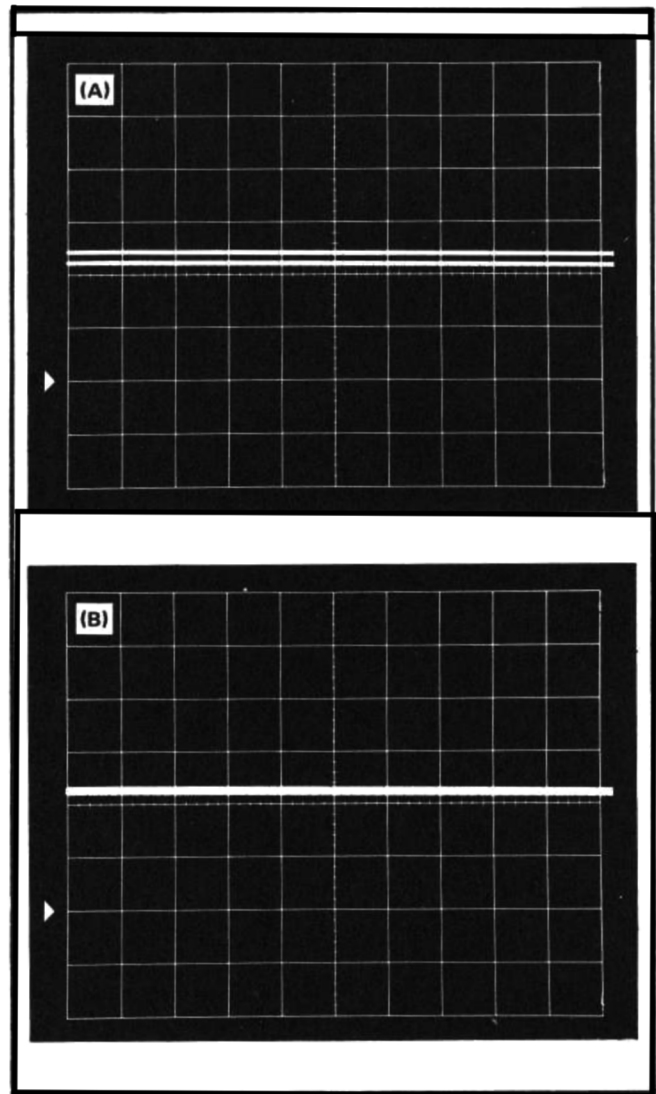

Fig. 5-6. Noise (Tangentially Measured). (A) CRT display showing noise and free running square wave. (B) CRT display showing the two noise bands merged.

20. Check Trigger Step Response

a. Equipment setup as in Step 18 except: Replace the extender signal cables to their correct jacks; connect the left trigger cable through the 2 ns cable to the Type 3S1 channel A input; connect the right trigger cable through the 2 ns cable to the channel B input.

b. CHECK—With the VOLTS/DIV switch set to 5 mV, check for a risetime of 2.1 nanoseconds or less and aberrations not to exceed +10%, -10% total of 15% P-P (use the Type 109 amplitude control to obtain a five division display).

NOTE

Risetime and aberrations are given as an aid to calibration and are not instrument specifications.

c. Reconnect the extender trigger cables to their proper jacks.

21. Check 20 Megahertz Bandwidth Limiting

- a. Set the Type 7A16 VOLTS/DIV to 10 mV.
- b. Connect a 20 megahertz signal from the Type 191 signal generator through a 5 nanosecond cable and a 50 ohm feed-through termination to the Type 7A16 INPUT.
- c. Adjust the Type 191 amplitude control for a six division display on the CRT.
- d. Press the BANDWIDTH 20 MHz pushbutton and adjust the Type 191 frequency control to obtain exactly 4.2 divisions of displayed amplitude.
- e. CHECK—The frequency, as read from the Type 191 frequency dial, must be 20 MHz within 3 MHz.
- f. Disconnect the 20 megahertz signal from the Type 7A16.

22. Check Overall Noise Level Tangentially

- a. Set the VOLTS/DIV to 5 mV and free run the time base.

b. Connect the Type 106 fast rise output through a GR to BNC adapter, BNC cable two 10× attenuators and a 50 ohm termination to the Type 7A16 INPUT. Set the Type 106 frequency to 1 kHz.

c. Increase the Type 106 amplitude until two noise bands are observed (noise and free running square wave). Decrease the amplitude until the two noise bands merge (dark line between the noise bands just disappears). See Fig. 5-6. The final adjustment should be made slowly.

d. Set the VOLTS/DIV to 50 mV and remove the two 10× attenuators.

e. CHECK—Adjust the time base for a stable display and check for a square wave amplitude of one division or less.

EXAMPLE:

$$\frac{\text{Tangentially Measure}}{\text{Noise}} = \frac{\text{Square Wave Amplitude}}{100} =$$

$$\frac{50 \text{ mV}}{100} = 0.5 \text{ mV}$$

PARTS LIST ABBREVIATIONS

BHB	binding head brass	int	internal
BHS	binding head steel	lg	length or long
cap.	capacitor	met.	metal
cer	ceramic	mtg hdw	mounting hardware
comp	composition	OD	outside diameter
conn	connector	OHB	oval head brass
CRT	cathode-ray tube	OHS	oval head steel
csk	countersunk	P/O	part of
DE	double end	PHB	pan head brass
dia	diameter	PHS	pan head steel
div	division	plstc	plastic
elect.	electrolytic	PMC	paper, metal cased
EMC	electrolytic, metal cased	poly	polystyrene
EMT	electrolytic, metal tubular	prec	precision
ext	external	PT	paper, tubular
F & I	focus and intensity	PTM	paper or plastic, tubular, molded
FHB	flat head brass	RHB	round head brass
FHS	flat head steel	RHS	round head steel
Fil HB	fillister head brass	SE	single end
Fil HS	fillister head steel	SN or S/N	serial number
h	height or high	S or SW	switch
hex.	hexagonal	TC	temperature compensated
HHB	hex head brass	THB	truss head brass
HHS	hex head steel	thk	thick
HSB	hex socket brass	THS	truss head steel
HSS	hex socket steel	tub.	tubular
ID	inside diameter	var	variable
inc	incandescent	w	wide or width
		WW	wire-wound

PARTS ORDERING INFORMATION

Replacement parts are available from or through your local Tektronix, Inc. Field Office or representative.

Changes to Tektronix instruments are sometimes made to accommodate improved components as they become available, and to give you the benefit of the latest circuit improvements developed in our engineering department. It is therefore important, when ordering parts, to include the following information in your order: Part number, instrument type or number, serial or model number, and modification number if applicable.

If a part you have ordered has been replaced with a new or improved part, your local Tektronix, Inc. Field Office or representative will contact you concerning any change in part number.

SPECIAL NOTES AND SYMBOLS

- | | |
|-----------------|-------------------------------------------------------------------------------------------------------------------------------|
| ×000 | Part first added at this serial number |
| 00× | Part removed after this serial number |
| *000-0000-00 | Asterisk preceding Tektronix Part Number indicates manufactured by or for Tektronix, Inc., or reworked or checked components. |
| Use 000-0000-00 | Part number indicated is direct replacement. |

INDEX OF ELECTRICAL PARTS LIST

Title	Page No.
CHASSIS	6-1
ATTENUATOR STRIP Assembly 1×	6-2
ATTENUATOR STRIP Assembly 2½×	6-2
ATTENUATOR STRIP Assembly 5×	6-2
ATTENUATOR STRIP Assembly 10×	6-3
ATTENUATOR STRIP Assembly 25×	6-3
ATTENUATOR STRIP Assembly 50×	6-3
ATTENUATOR STRIP Assembly 100×	6-4
ATTENUATOR STRIP Assembly 250×	6-4
AC-DC-GND RELAY Circuit Board Assembly	6-5
VERTICAL AMPLIFIER Circuit Board Assembly	6-5
AC-DC-GND Switch Circuit Board Assembly	6-12
POLARITY Switch Circuit Board Assembly	6-12
BANDWIDTH Switch Circuit Board Assembly	6-12

SECTION 6

ELECTRICAL PARTS LIST

Values are fixed unless marked Variable.

Ckt. No.	Tektronix Part No.	Serial/Model No. Eff	No. Disc	Description
----------	--------------------	----------------------	----------	-------------

CHASSIS

Capacitors

Tolerance $\pm 20\%$ unless otherwise indicated.

C3 ¹						
C4	281-0697-00		5000 pF	Cer	100 V	+100% -0%
C14	283-0674-00		85 pF	Mica	100 V	1%
C200	281-0697-00		5000 pF	Cer	100 V	+100% -0%

Connector

J1	131-0725-01			BNC, receptacle, electrical
----	-------------	--	--	-----------------------------

Semiconductor Device, Diode

CR210	*152-0185-00		Silicon	Replaceable by 1N4152
-------	--------------	--	---------	-----------------------

Inductors

L4	*120-0382-00			Toroid, 14 turns, single
L200	*120-0382-00			Toroid, 14 turns, single

Resistors

Resistors are fixed, composition, $\pm 10\%$ unless otherwise indicated.

R14	321-0756-03		50 k Ω	$\frac{1}{8}$ W	Prec	$\frac{1}{4}\%$
R115 ²	311-0652-00		2 x 5 k Ω , Var			
R153	311-0443-00		2.5 k Ω , Var			

Switches

Wired or Unwired

S10	Wired	*263-0009-00		Rotary	VOLTS/DIV
S10		263-0510-00			
S115 ³					IDENTIFY

¹Furnished as a unit with J1.

²Furnished as a unit with S115.

³Furnished as a unit with R115.

ATTENUATOR STRIP Assembly 1 X

Ckt. No.	Tektronix Part No.	Serial/Model No. Eff	Disc	Description
	*307-1001-00			Complete Attenuator Strip
C5 ⁴				Capacitor
R5 ⁴				Resistor

ATTENUATOR STRIP Assembly 2½ X

	*307-1002-00			Complete Attenuator Strip
C6A ⁵ C6B ⁵ C6C ⁵				Capacitors
R6A ⁵ R6B ⁵ R6C ⁵				Resistors

ATTENUATOR STRIP Assembly 5 X

	*307-1003-00			Complete Attenuator Strip
C7A ⁶ C7B ⁶				Capacitors
R7A ⁶ R7B ⁶ R7C ⁶				Resistors

⁴Furnished as a unit with *307-1001-00.

⁵Furnished as a unit with *307-1002-00.

⁶Furnished as a unit with *307-1003-00.

ATTENUATOR STRIP Assembly 10 X

Ckt. No.	Tektronix Part No.	Serial/Model No. Eff Disc	Description
----------	-----------------------	------------------------------	-------------

*307-1004-00 Complete Attenuator Strip

Capacitors

C8A⁷
C8B⁷
C8C⁷

Resistors

R8A⁷
R8B⁷
R8C⁷

ATTENUATOR STRIP Assembly 25 X

*307-1005-00 Complete Attenuator Strip

Capacitors

C9A⁸
C9B⁸
C9C⁸

Resistors

R9A⁸
R9B⁸
R9C⁸

ATTENUATOR STRIP Assembly 50 X

*307-1006-00 Complete Attenuator Strip

Capacitors

C10A⁹
C10B⁹
C10C⁹

⁷Furnished as a unit with *307-1004-00.

⁸Furnished as a unit with *307-1005-00.

⁹Furnished as a unit with *307-1006-00.

ATTENUATOR STRIP Assembly 50 X (cont)

Ckt. No.	Tektronix Part No.	Serial/Model No. Eff Disc	Description
----------	-----------------------	------------------------------	-------------

Resistors

R10A¹⁰
R10B¹⁰
R10C¹⁰

ATTENUATOR STRIP Assembly 100 X

*307-1007-00 Complete Attenuator Strip

Capacitors

C11A¹¹
C11B¹¹
C11C¹¹

Resistors

R11A¹¹
R11B¹¹
R11C¹¹

ATTENUATOR STRIP Assembly 250 X

*307-1008-00 Complete Attenuator Strip

Capacitors

C12A¹²
C12B¹²
C12C¹²

Resistors

R12A¹²
R12B¹²
R12C¹²

¹⁰Furnished as a unit with *307-1006-00.

¹¹Furnished as a unit with *307-1007-00.

¹²Furnished as a unit with *307-1008-00.

AC-DC-GND RELAY Circuit Board Assembly

Ckt. No.	Tektronix Part No.	Serial/Model No. Eff	No. Disc	Description
----------	--------------------	----------------------	----------	-------------

*670-1092-00 Complete Board

Capacitor

Tolerance $\pm 20\%$ unless otherwise indicated.

C2	283-0160-00		1.5 pF	Cer	50 V	10%
----	-------------	--	--------	-----	------	-----

Relay

K5 S5A, B }	*148-0063-00			Polarized, 200 mW, dpat, 5 pin		
----------------	--------------	--	--	--------------------------------	--	--

Resistors

Resistors are fixed, composition, $\pm 10\%$ unless otherwise indicated.

R1	317-0620-00		62 Ω	$\frac{1}{8}$ W		5%
R2	317-0620-00		62 Ω	$\frac{1}{8}$ W		5%
R3	317-0105-00		1 M Ω	$\frac{1}{8}$ W		5%

VERTICAL AMPLIFIER Circuit Board Assembly

*670-1113-00	B010100	B019999	Complete Board
*670-1113-01	B020000	B029999	Complete Board
*670-1113-02	B030000	B039999	Complete Board
*670-1113-03	B040000	B049999	Complete Board
*670-1113-04	B050000	B059999	Complete Board
*670-1113-05	B060000		Complete Board

Capacitors

Tolerance $\pm 20\%$ unless otherwise indicated.

C18	281-0064-00		0.25-1.5 pF, Var	Tub.		
C20	283-0080-00		0.022 μ F	Cer	25 V	+ 80% - 20%
C23	283-0059-00		1 μ F	Cer	25 V	+ 80% - 20%
C24	290-0135-00	XB060000	15 μ F	Elect.	20 V	
C28	281-0651-00		47 pF	Cer		5%
C30	283-0080-00		0.022 μ F	Cer	25 V	+ 80% - 20%
C34	283-0080-00		0.022 μ F	Cer	25 V	+ 80% - 20%
C35	283-0178-00		0.1 μ F	Cer	100 V	+ 80% - 20%
C36	283-0080-00		0.022 μ F	Cer	25 V	+ 80% - 20%
C40	283-0060-00		100 pF	Cer	200 V	5%

VERTICAL AMPLIFIER Circuit Board Assembly (cont)

Ckt. No.	Tektronix Part No.	Serial/Model No. Eff	Disc	Description	
Capacitors (cont)					
C45	281-0123-00			5-25 pF, Var	Cer 100 V
C52	281-0123-00			5-25 pF, Var	Cer 100 V
C55	283-0060-00			100 pF	Cer 200 V
C56	283-0059-00			1 μ F	Cer 25 V
C57	290-0135-00	XB060000		15 μ F	Elect. 20 V
C61	281-0122-00			2.5-9 pF, Var	Cer 100 V
C65	281-0656-00			22 pF	Cer 200 V 5%
C68	283-0065-00			0.001 μ F	Cer 100 V 5%
C77	281-0577-00			14 pF	Cer 500 V 5%
C85	281-0656-00			22 pF	Cer 200 V 5%
C88	283-0065-00			0.001 μ F	Cer 100 V 5%
C89	283-0178-00			0.1 μ F	Cer 100 V +80%—20%
C97	283-0629-00			62 pF	Mica 500 V 1%
C102	281-0122-00			2.5-9 pF, Var	Cer 100 V
C103	281-0122-00			2.5-9 pF, Var	Cer 100 V
C104	283-0178-00			0.1 μ F	Cer 100 V +80%—20%
C105	283-0077-00			330 pF	Cer 500 V 5%
C109	281-0122-00			2.5-9 pF, Var	Cer 100 V
C111	281-0122-00			2.5-9 pF, Var	Cer 100 V
C112	281-0601-00			7.5 pF	Cer 500 V ± 0.5 pF
C124	283-0077-00			330 pF	Cer 500 V 5%
C125	283-0065-00			0.001 μ F	Cer 100 V 5%
C130	283-0185-00			2.5 pF	Cer 50 V 5%
C131	283-0080-00			0.022 μ F	Cer 25 V +80%—20%
C133	283-0065-00			0.001 μ F	Cer 100 V 5%
C138	281-0613-00			10 pF	Cer 200 V 10%
C140	283-0178-00			0.1 μ F	Cer 100 V +80%—20%
C143	283-0080-00			0.022 μ F	Cer 25 V +80%—20%
C145	281-0612-00			5.6 pF	Cer 200 V ± 0.5 pF
C155	283-0077-00			330 pF	Cer 500 V 5%
C162	281-0601-00			7.5 pF	Cer 500 V ± 0.5 pF
C164	283-0077-00			330 pF	Cer 500 V 5%
C165	283-0065-00			0.001 μ F	Cer 100 V 5%
C169	281-0617-00			15 pF	Cer 200 V
C173	283-0065-00			0.001 μ F	Cer 100 V 5%
C178	281-0613-00			10 pF	Cer 200 V 10%
C185	281-0612-00			5.6 pF	Cer 200 V ± 0.5 pF
C234	290-0135-00			15 μ F	Elect. 20 V
C235	283-0178-00			0.1 μ F	Cer 100 V +80%—20%
C236	283-0065-00			0.001 μ F	Cer 100 V 5%
C237	290-0135-00			15 μ F	Elect. 20 V
C238	283-0178-00			0.1 μ F	Cer 100 V +80%—20%
C239	283-0065-00			0.001 μ F	Cer 100 V 5%

VERTICAL AMPLIFIER Circuit Board Assembly (cont)

Ckt. No.	Tektronix Part No.	Serial/Model No. Eff	No. Disc	Description	
Semiconductor Device, Diodes					
VR20	152-0278-00	B010100	B029999	Zener	1N4372A 400 mW, 3 V, 5%
VR20	152-0279-00	B030000		Zener	1N751A 400 mW, 5.1 V, 5%
CR29	*152-0323-00			Silicon	Tek Spec
CR30	*152-0153-00			Silicon	Tek Spec
VR30	152-0278-00	B010100	B029999	Zener	1N4372A 400 mW, 3 V, 5%
VR30	152-0279-00	B030000		Zener	1N751A 400 mW, 5.1 V, 5%
VR123	152-0166-00			Zener	1N753A 400 mW, 6.2 V, 5%
CR128	152-0422-00			Silicon	Voltage Variable Capacitance
CR168	152-0422-00			Silicon	Voltage Variable Capacitance
CR200	*152-0185-00			Silicon	Replaceable by 1N4152
CR220	*152-0185-00	XB060000		Silicon	Replaceable by 1N4152
CR222	*152-0185-00	XB060000		Silicon	Replaceable by 1N4152
CR224	*152-0185-00			Silicon	Replaceable by 1N4152
CR226	*152-0185-00			Silicon	Replaceable by 1N4152
CR227	*152-0185-00			Silicon	Replaceable by 1N4152
CR228	*152-0185-00			Silicon	Replaceable by 1N4152
Relays					
K65	*148-0034-00			Armature, dpdt	15 V DC
K75	*148-0034-00			Armature, dpdt	15 V DC
K105	*148-0035-00			Armature, spdt	15 V DC
K110	*148-0035-00			Armature, spdt	15 V DC
K115	*148-0034-00			Armature, spdt	15 V DC
K155	*148-0035-00			Armature, spdt	15 V DC
K160	*148-0035-00			Armature, spdt	15 V DC
Inductors					
L20	*108-0440-00	B010100	B059999	8 μ H	
L20	*120-0382-00	B060000		Toroid, 14 turns, single	
L30	*108-0440-00	B010100	B059999	8 μ H	
L30	*120-0382-00	B060000		Toroid, 14 turns, single	
L34	276-0507-00			Core, ferramic suppressor	
L68	276-0507-00			Core, ferramic suppressor	
L76	*108-0170-01			0.5 μ H	
L88	276-0507-00			Core, ferramic suppressor	
L96	*108-0170-01			0.5 μ H	
L97	276-0507-00			Core, ferramic suppressor	
L131	*108-0440-00			8 μ H	
L133	276-0507-00			Core, ferramic suppressor	

VERTICAL AMPLIFIER Circuit Board Assembly (cont)

Ckt. No.	Tektronix Part No.	Serial/Model No. Eff	No. Disc	Description
----------	--------------------	----------------------	----------	-------------

Inductors (cont)

L140	*108-0440-00			8 μ H
L143	*108-0440-00			8 μ H
L173	276-0507-00			Core, ferramic suppressor
L230	*120-0382-00			Toroid, 14 turns, single
L236	*120-0382-00			Toroid, 14 turns, single
L238	*120-0382-00			Toroid, 14 turns, single
LR159	*108-0568-00			75 nH (wound on a 68 Ω , 1/8 W, 5% resistor)

Transistors

Q20	151-1032-00			Silicon	FET, dual
Q40 } Q50 } Q60 } Q70 }	*153-0580-00			Silicon	Selected, Tek Spec
	*151-0268-00			Silicon	Tek Spec, dual
	*151-0212-00			Silicon	Tek Spec
Q90	*151-0212-00			Silicon	Tek Spec
Q100	*151-0272-00			Silicon	Tek Spec, dual
Q120	*151-0272-00			Silicon	Tek Spec, dual
Q125	*151-0212-00			Silicon	Tek Spec
Q130	*151-0259-00	B010100	B039999	Silicon	Selected from 2N3563
Q130	*151-0269-00	B040000		Silicon	Selected from SE3005
Q135	*151-0212-00			Silicon	Tek Spec
Q140	151-0298-00			Silicon	NPN, TO-72, MM1606
Q165	*151-0212-00			Silicon	Tek Spec
Q170	*151-0259-00	B010100	B039999	Silicon	Selected from 2N3563
Q170	*151-0269-00	B040000		Silicon	Selected from SE3005
Q175	*151-0212-00			Silicon	Tek Spec
Q180	151-0298-00			Silicon	NPN, TO-72, MM1606
Q200	151-0254-00			Silicon	TO-98, D16P4

Resistors

Resistors are fixed, composition, $\pm 10\%$ unless otherwise indicated.

R17	323-0612-03	950 k Ω	1/2 W	Prec	1/4 %
R18	315-0561-00	560 Ω	1/4 W		5%
R23	317-0151-00	150 Ω	1/8 W		5%
R28	325-0041-00	19.75 Ω	1/20 W	Prec	1%
R30	325-0041-00	19.75 Ω	1/20 W	Prec	1%
R31	315-0472-00	4.7 k Ω	1/4 W		
R34	311-0462-00	1 k Ω , Var			5%
R35	315-0913-00	91 k Ω	1/4 W		5%
R38	317-0151-00	150 Ω	1/8 W		5%
R40	311-0634-00	500 Ω , Var			5%

VERTICAL AMPLIFIER Circuit Board Assembly (cont)

Ckt. No.	Tektronix Part No.	Serial/Model No. Eff	No. Disc	Description		
Resistors (cont)						
R43	315-0182-00			1.8 k Ω	1/4 W	5%
R45	317-0470-00			47 Ω	1/8 W	5%
R51	315-0182-00			1.8 k Ω	1/4 W	5%
R52	317-0560-00			56 Ω	1/8 W	5%
R55	311-0634-00			500 Ω , Var		
R60	321-0062-00			43.2 Ω	1/8 W	Prec 1%
R61	311-0605-00			200 Ω , Var		
R62	323-0175-00			649 Ω	1/2 W	Prec 1%
R64	321-0114-00	B010100	B019999	150 Ω	1/8 W	Prec 1%
R64	321-0097-00	B020000	B049999	100 Ω	1/8 W	Prec 1%
R64	321-0076-00	B050000		60.4 Ω	1/8 W	Prec 1%
R65	321-0033-00	B010100	B049999	21.5 Ω	1/8 W	Prec 1%
R65	321-0024-00	B050000		17.4 Ω	1/8 W	Prec 1%
R66	311-0963-00			5 k Ω , Var		
R67	315-0153-00			15 k Ω	1/4 W	5%
R68	317-0241-00			240 Ω	1/8 W	5%
R70	325-0053-00			50 Ω	1/20 W	Prec 1%
R71	325-0053-00			50 Ω	1/20 W	Prec 1%
R73	321-0186-00			845 Ω	1/8 W	Prec 1%
R74	321-0177-00			681 Ω	1/8 W	Prec 1%
R80	321-0062-00			43.2 Ω	1/8 W	Prec 1%
R82	317-0200-00			20 Ω	1/8 W	5%
R84	321-0114-00	B010100	B019999	150 Ω	1/8 W	Prec 1%
R84	321-0097-00	B020000	B049999	100 Ω	1/8 W	Prec 1%
R84	321-0076-00	B050000		60.4 Ω	1/8 W	Prec 1%
R85	321-0033-00	B010100	B049999	21.5 Ω	1/8 W	Prec 1%
R85	321-0024-00	B050000		17.4 Ω	1/8 W	Prec 1%
R86	311-0963-00			5 k Ω , Var		
R87	315-0153-00			15 k Ω	1/4 W	5%
R88	317-0301-00			300 Ω	1/8 W	5%
R89	311-0510-00			10 k Ω , Var		
R90	325-0053-00			50 Ω	1/20 W	Prec 1%
R100	321-0085-00			75 Ω	1/8 W	Prec 1%
R101	323-0135-00			249 Ω	1/2 W	Prec 1%
R102	321-0039-00			24.9 Ω	1/8 W	Prec 1%
R103	311-0635-00			1 k Ω , Var		
R104	323-0114-00			150 Ω	1/2 W	Prec 1%
R105	317-0331-00			350 Ω	1/8 W	5%
R106	322-0193-00			1 k Ω	1/4 W	Prec 1%
R108	325-0047-00			25 Ω	1/20 W	Prec 1/2%
R109	311-0634-00			500 Ω , Var		
R111	311-0634-00			500 Ω , Var		
R112	325-0045-00			46.4 Ω	1/20 W	Prec 1/2%
R114	315-0103-00			10 k Ω	1/4 W	5%
R117	311-0442-00			250 Ω , Var		
R118	322-0206-00			1.37 k Ω	1/4 W	Prec 1%

VERTICAL AMPLIFIER Circuit Board Assembly (cont)

Ckt. No.	Tektronix Part No.	Serial/Model No. Eff	Disc	Description		
Resistors (cont)						
R120	321-0085-00		75 Ω	1/8 W	Prec	1%
R121	322-0207-00		1.4 kΩ	1/4 W	Prec	1%
R123	321-0114-00		150 Ω	1/8 W	Prec	1%
R124	317-0391-00		390 Ω	1/8 W		5%
R125	317-0241-00		240 Ω	1/8 W		5%
R126	321-0434-00		324 kΩ	1/8 W	Prec	1%
R127	321-0068-00		49.9 Ω	1/8 W	Prec	1%
R128	321-0068-00		49.9 Ω	1/8 W	Prec	1%
RT128	307-0181-00		100 kΩ	Thermal		
R129	322-0147-00		332 Ω	1/4 W	Prec	1%
R130	321-0062-00		43.2 Ω	1/8 W	Prec	1%
R131	323-0142-00		294 Ω	1/2 W	Prec	1%
R133	317-0241-00		240 Ω	1/8 W		5%
R135	321-0135-00		249 Ω	1/8 W	Prec	1%
R137	323-0171-00		590 Ω	1/2 W	Prec	1%
R138	321-0062-00		43.2 Ω	1/8 W	Prec	1%
R141	323-0167-00		536 Ω	1/2 W	Prec	1%
R142	321-0135-00		249 Ω	1/8 W	Prec	1%
R143	323-0146-00		324 Ω	1/2 W	Prec	1%
R145	321-0062-00		43.2 Ω	1/8 W	Prec	1%
R150	321-0085-00		75 Ω	1/8 W	Prec	1%
R151	321-0039-00		24.9 Ω	1/8 W	Prec	1%
R154	315-0103-00		10 kΩ	1/4 W		5%
R155	317-0331-00		330 Ω	1/8 W		5%
R156	322-0193-00		1 kΩ	1/4 W	Prec	1%
R158	325-0047-00		25 Ω	1/20 W	Prec	1/2%
R159	325-0044-00		100 Ω	1/20 W	Prec	1/2%
R160	315-0103-00		10 kΩ	1/4 W		5%
R161	325-0044-00		100 Ω	1/20 W	Prec	1/2%
R162	325-0045-00		46.4 Ω	1/20 W	Prec	1/2%
R163	321-0114-00		150 Ω	1/8 W	Prec	1%
R164	317-0391-00		390 Ω	1/8 W		5%
R165	317-0241-00		240 Ω	1/8 W		5%
R166	322-0206-00		1.37 kΩ	1/4 W	Prec	1%
R167	321-0068-00		49.9 Ω	1/8 W	Prec	1%
R168	321-0068-00		49.9 Ω	1/8 W	Prec	1%
R169	317-0472-00		4.7 kΩ	1/8 W		5%
R170	321-0062-00		43.2 Ω	1/8 W	Prec	1%
R172	321-0196-00		1.07 kΩ	1/8 W	Prec	1%
R173	317-0241-00		240 Ω	1/8 W		5%

VERTICAL AMPLIFIER Circuit Board Assembly (cont)

Ckt. No.	Tektronix Part No.	Serial/Model No. Eff	No. Disc	Description		
Resistors (cont)						
R174	323-0149-00		348 Ω	$\frac{1}{2}$ W	Prec	1%
R175	321-0135-00		249 Ω	$\frac{1}{8}$ W	Prec	1%
R177	323-0171-00		590 Ω	$\frac{1}{2}$ W	Prec	1%
R178	321-0062-00		43.2 Ω	$\frac{1}{8}$ W	Prec	1%
R181	323-0167-00		536 Ω	$\frac{1}{2}$ W	Prec	1%
R182	321-0135-00		249 Ω	$\frac{1}{8}$ W	Prec	1%
R185	321-0062-00		43.2 Ω	$\frac{1}{8}$ W	Prec	1%
R200	315-0184-00		180 k Ω	$\frac{1}{4}$ W		5%
R202	322-0223-00		2.05 k Ω	$\frac{1}{4}$ W	Prec	1%
R204	321-0299-00		12.7 k Ω	$\frac{1}{8}$ W	Prec	1%
R205	321-0344-00		37.4 k Ω	$\frac{1}{8}$ W	Prec	6%
R206	315-0753-00		75 k Ω	$\frac{1}{4}$ W		5%
R207	315-0753-00		75 k Ω	$\frac{1}{4}$ W		5%
R208	315-0154-00		150 k Ω	$\frac{1}{4}$ W	Prec	1%
R209	321-0344-00		37.4 k Ω	$\frac{1}{8}$ W		5%
R218	315-0154-00		150 k Ω	$\frac{1}{4}$ W		5%
R219	315-0154-00		150 k Ω	$\frac{1}{4}$ W		5%
R220	315-0133-00		13 k Ω	$\frac{1}{4}$ W		5%
R222	315-0154-00		150 k Ω	$\frac{1}{4}$ W		5%
R224	315-0154-00		150 k Ω	$\frac{1}{4}$ W		5%
R225	315-0513-00		51 k Ω	$\frac{1}{4}$ W		5%
R226	315-0154-00		150 k Ω	$\frac{1}{4}$ W		5%
R228	315-0753-00		75 k Ω	$\frac{1}{4}$ W		5%
R232	315-0510-00		51 Ω	$\frac{1}{4}$ W		5%
R233	315-0753-00		75 k Ω	$\frac{1}{4}$ W		5%
R234	315-0510-00		51 Ω	$\frac{1}{4}$ W		5%
R235	307-0103-00		2.7 Ω	$\frac{1}{4}$ W		5%
R236	315-0101-00		100 Ω	$\frac{1}{4}$ W		5%
R238	315-0101-00		100 Ω	$\frac{1}{4}$ W		5%
R239	315-0470-00		47 Ω	$\frac{1}{4}$ W		5%

Switch

	Wired or Unwired		
S65 ¹³	*670-1134-00	Slide	VARIABLE CAL IN

¹³See Mechanical Parts List for replacement parts.

AC-DC-GND Switch Circuit Board Assembly

Ckt. No.	Tektronix Part No.	Serial/Model No. Eff	Disc	Description
	*670-1124-00	B010100	B069999	Complete Board
	*670-1124-01	B070000		Complete Board

Bulb

DS3	*150-0057-01	B010100	B069999	Incandescent	7153AS15, selected
D53	*150-0048-01	B070000		Incandescent	#683, selected

Switch

Wired or Unwired

S3 ¹⁴	*670-1124-00	B010100	B069999	Pushbutton	AC-GND-DC
S3 ¹⁴	*670-1124-01	B070000		Pushbutton	AC-GND-DC

POLARITY Switch Circuit Board Assembly

	*670-1125-00	B010100	B069999	Complete Board
	*670-1125-01	B070000		Complete Board

Bulb

DS118	*150-0057-01	B010100	B069999	Incandescent	7153AS15, selected
DS118	*150-0048-01	B070000		Incandescent	#683, selected

Switch

Wired or Unwired

S118 ¹⁴	*670-1125-00	B010100	B069999	Pushbutton	INVERT
S118 ¹⁴	*670-1125-01	B070000		Pushbutton	INVERT

BANDWIDTH Switch Circuit Board Assembly

	*670-1126-00	B010100	B069999	Complete Board
	*670-1126-01	B070000		Complete Board

Bulb

DS75	*150-0057-01	B010100	B069999	Incandescent	7153AS15, selected
DS75	*150-0048-01	B070000		Incandescent	#683, selected

Switch

Wired or Unwired

S75 ¹⁴	*670-1126-00	B010100	B069999	Pushbutton	BANDWIDTH
S75 ¹⁴	*670-1126-01	B070000		Pushbutton	BANDWIDTH

¹⁴See Mechanical Parts List for replacement parts.

SECTION 7 DIAGRAMS and MECHANICAL PARTS ILLUSTRATIONS

The following special symbols are used on the diagrams:

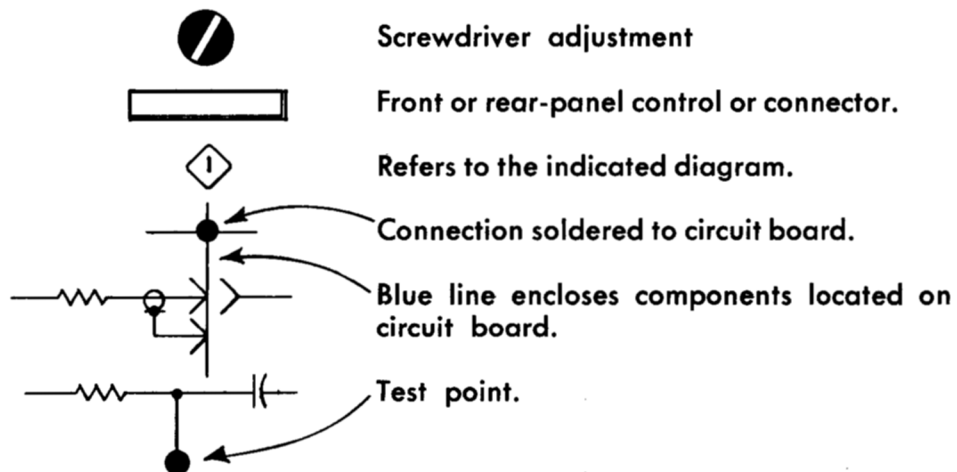

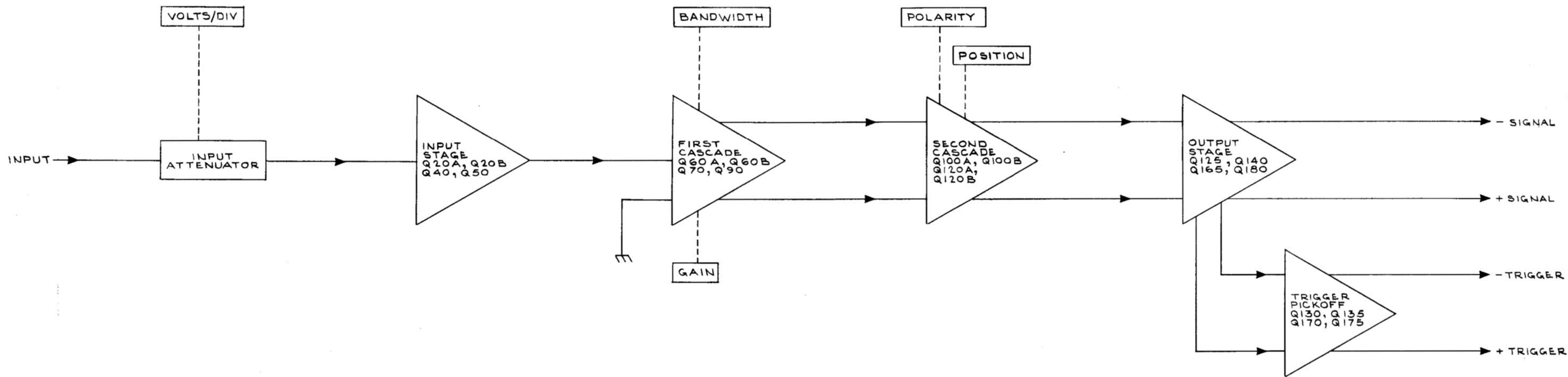

7A16 AMPLIFIER

BLOCK DIAGRAM

hq
1069

VOLTAGE AND WAVEFORM TEST CONDITIONS

Typical voltage measurements and waveform photographs were obtained under the following conditions unless noted otherwise on the individual diagrams:

Type 7704 Oscilloscope

Vertical Mode	Right
Horizontal Mode	A

Type 7A16 Controls (left vertical compartment)

POLARITY	+UP
BANDWIDTH	FULL
AC-GND-DC	DC
VOLTS/DIV	10 mV
INPUT	50 mV from a Standard Amplitude Calibrator

Type 7A16 Controls (right vertical compartment)

Use a 10X attenuator probe

Polarity	+Up
Bandwidth	Full
AC-GND-DC	AC
Volts/Div	10 mV

Type 7B71 Controls (A horizontal compartment)

Level/Slope	0/+
Triggering Mode	P-P Auto
Coupling	AC
Source	Ext
Magnifier	X1
Time/Div	1 ms
Variable	Cal In
Ext Trig In	Positive trigger signal (A13) from the Type 7A16 in the left vertical compartment.

All voltages given on the diagrams are in volts. Waveforms shown are actual waveform photographs taken with a Tektronix Oscilloscope Camera System. Voltages and waveforms on the diagrams (shown in blue) are not absolute and may vary between instruments because of differing component tolerances, internal calibration or front-panel control settings.

NOTE

Vertical deflection factor shown on waveforms does not include attenuation factor of the 10X Probe.

1X

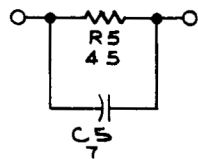

2 1/2 X

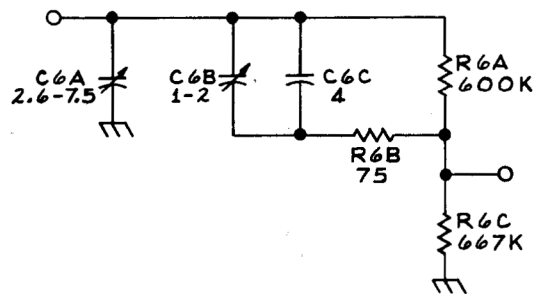

5X

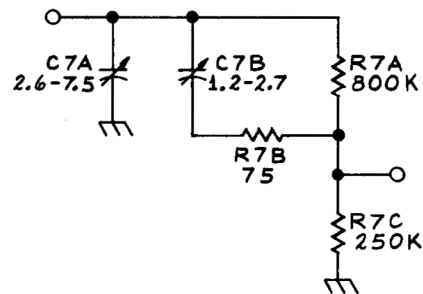

10X

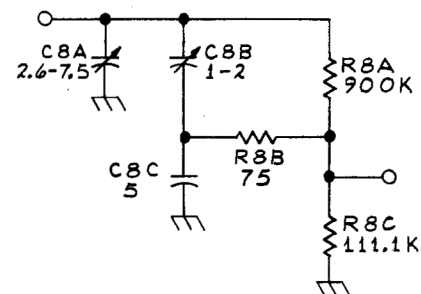

25X

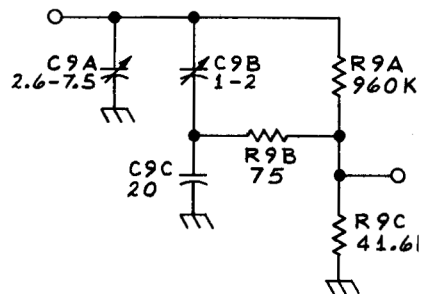

50X

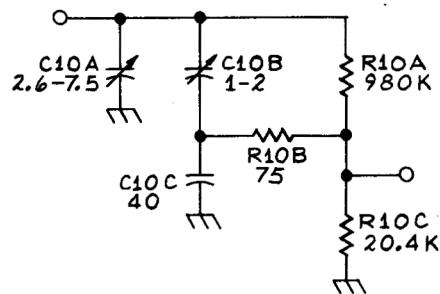

100X

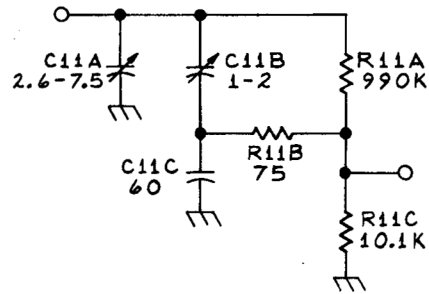

250X

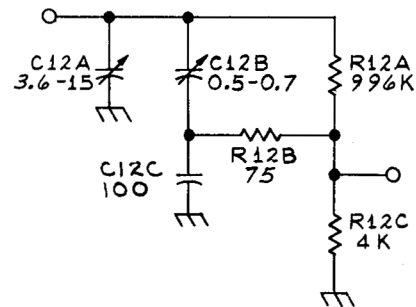

7A16 AMPLIFIER

ATTENUATORS  WLB 1069

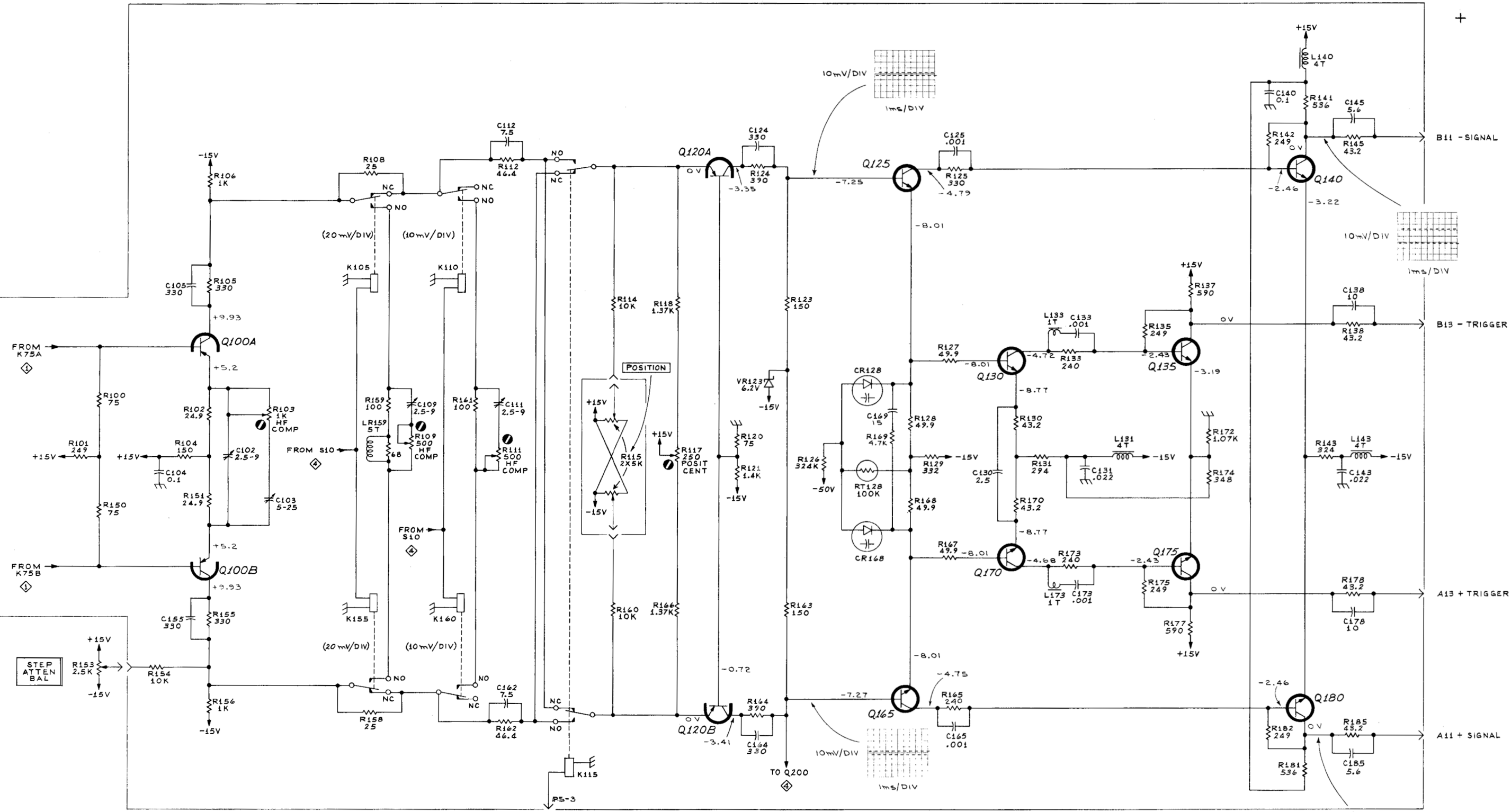

PARTIAL VERTICAL AMPLIFIER BOARD

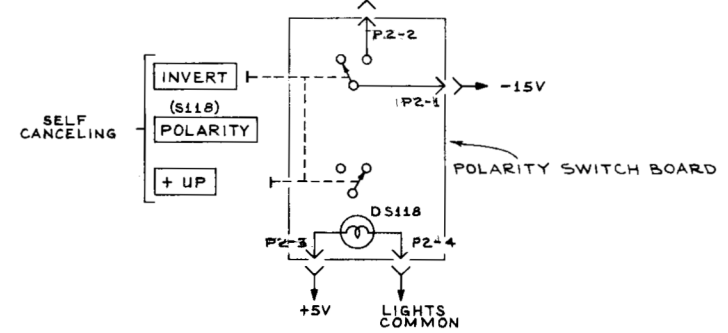

NOTE:
SEE PARTS LIST FOR SEMICONDUCTOR TYPES.

VOLTAGES and WAVEFORMS obtained under conditions given on diagram \diamond except as follows:
VOLTAGES only no signal applied

REFERENCE DIAGRAM
 \diamond INPUT AMPLIFIER
 \diamond SWITCHING & INTERCONNECTING PLUG

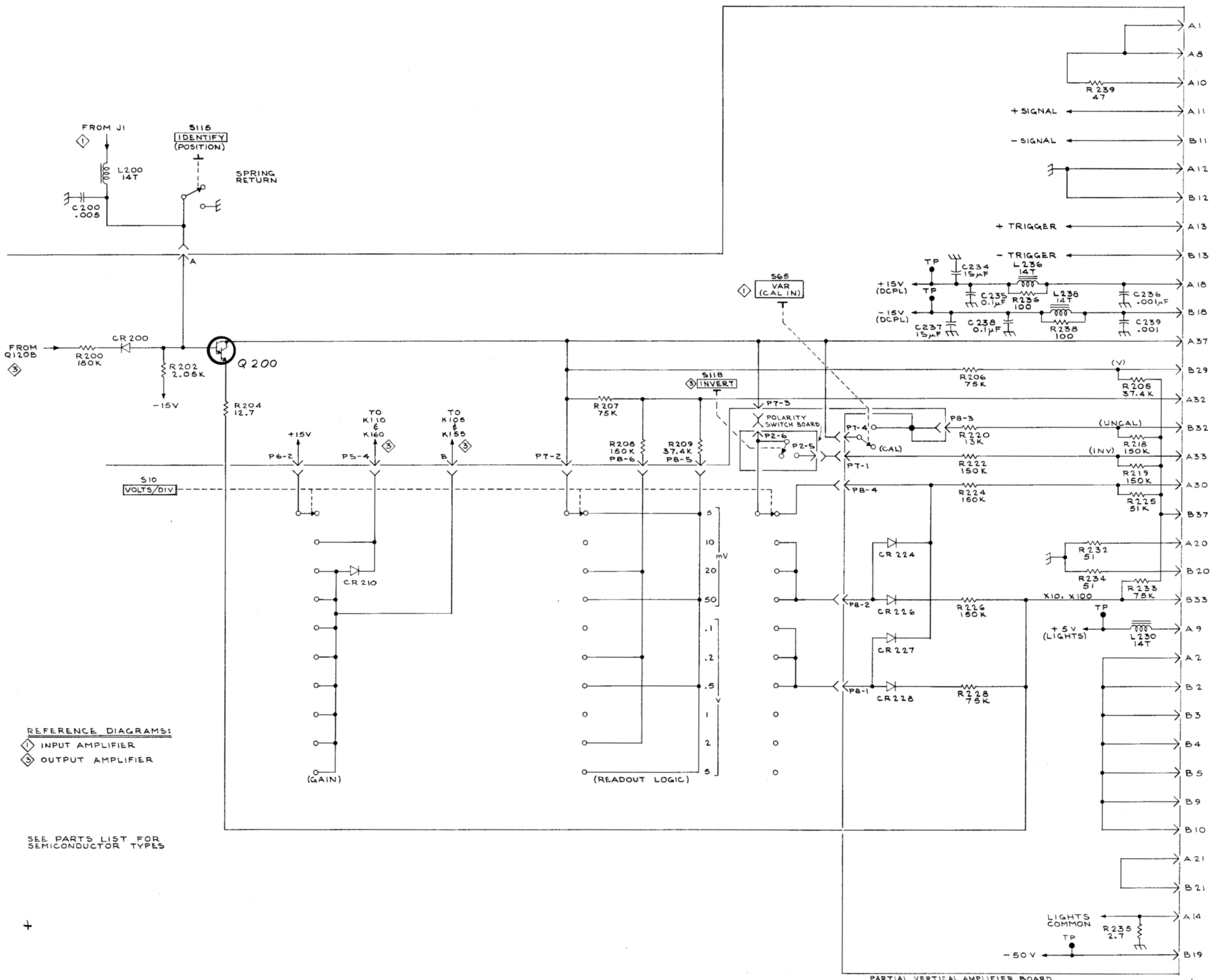

REFERENCE DIAGRAMS:
 ① INPUT AMPLIFIER
 ③ OUTPUT AMPLIFIER

SEE PARTS LIST FOR SEMICONDUCTOR TYPES

FIGURE AND INDEX NUMBERS

Items in this section are referenced by figure and index numbers to the illustrations which appear either on the back of the diagrams or on pullout pages immediately following the diagrams of the instruction manual.

INDENTATION SYSTEM

This mechanical parts list is indented to indicate item relationships. Following is an example of the indentation system used in the Description column.

Assembly and/or Component
Detail Part of Assembly and/or Component
mounting hardware for Detail Part
Parts of Detail Part
mounting hardware for Parts of Detail Part
mounting hardware for Assembly and/or Component

Mounting hardware always appears in the same indentation as the item it mounts, while the detail parts are indented to the right. Indented items are part of, and included with, the next higher indentation.

Mounting hardware must be purchased separately, unless otherwise specified.

PARTS ORDERING INFORMATION

Replacement parts are available from or through your local Tektronix, Inc. Field Office or representative.

Changes to Tektronix instruments are sometimes made to accommodate improved components as they become available, and to give you the benefit of the latest circuit improvements developed in our engineering department. It is therefore important, when ordering parts, to include the following information in your order: Part number, instrument type or number, serial or model number, and modification number if applicable.

If a part you have ordered has been replaced with a new or improved part, your local Tektronix, Inc. Field Office or representative will contact you concerning any change in part number.

Change information, if any, is located at the rear of this manual.

ABBREVIATIONS AND SYMBOLS

For an explanation of the abbreviations and symbols used in this section, please refer to the page immediately preceding the Electrical Parts List in this instruction manual.

INDEX OF MECHANICAL PARTS ILLUSTRATION

Title	Location (reverse side of)
Figure 1 Exploded	Switching & Interconnecting Plug Diagram

FIGURE 1 EXPLODED

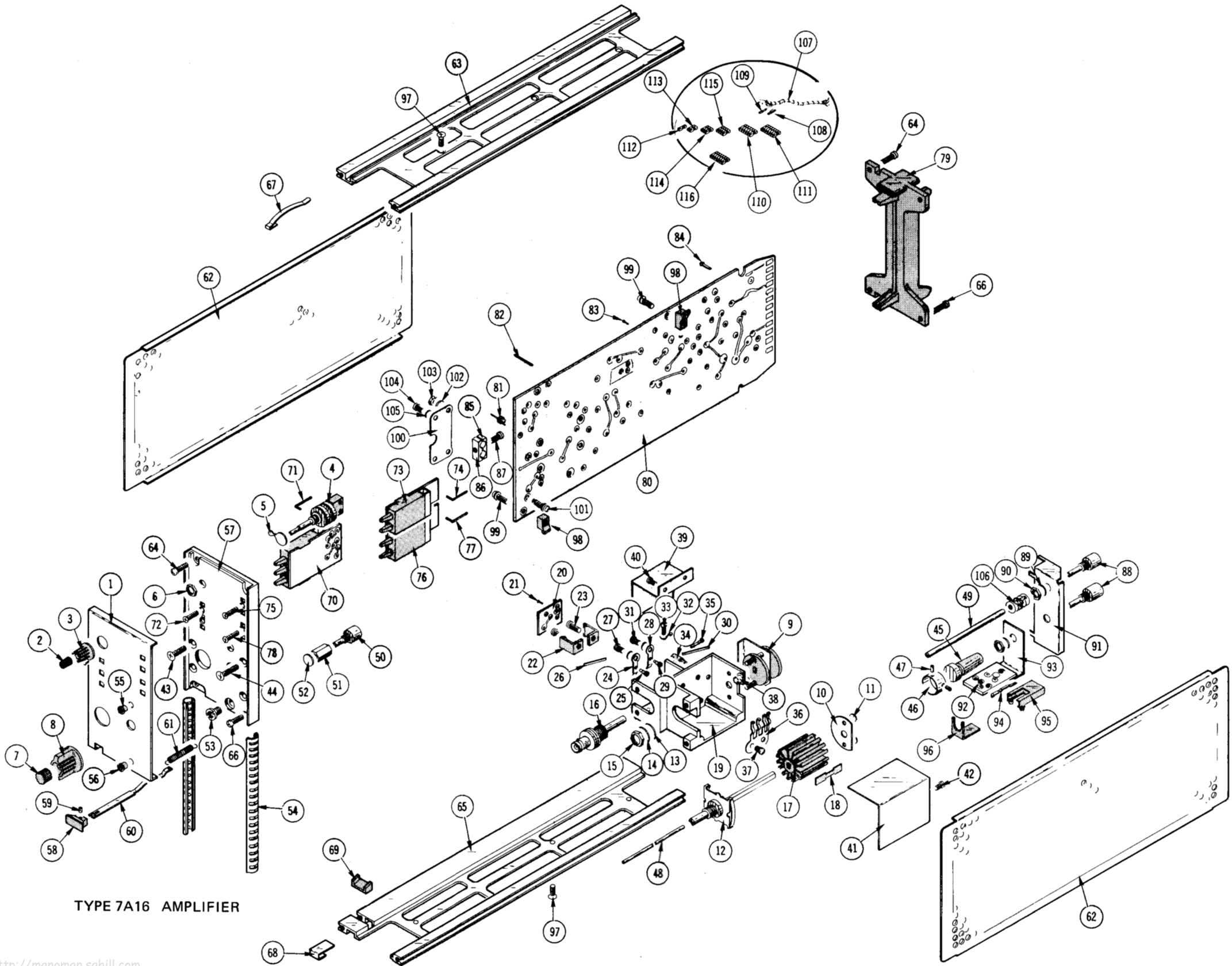

TYPE 7A16 AMPLIFIER

SECTION 8

MECHANICAL PARTS LIST

FIGURE 1 EXPLODED

Fig. & Index No.	Tektronix Part No.	Serial/Model No. Eff	No. Disc	Q					Description	
				t	y	1	2	3		4
1-1	333-1151-00			1						PANEL, front
-2	366-1059-00			1						KNOB, gray—IDENTIFY
-3	366-1077-00			1						KNOB, gray—POSITION
				-						knob includes:
	213-0153-00			1						SETSCREW, 5-40 x 1/8 inch, HSS
-4				1						RESISTOR, variable
				-						mounting hardware: (not included w/resistor)
-5	210-0223-01			1						TERMINAL, lug
-6	210-0583-00			1						NUT, hex., 1/4-32 x 5/16 inch
-7	366-1168-00			1						KNOB, red-black—VARIABLE (CAL IN)
				-						knob includes:
	213-0153-00			1						SETSCREW, 5-40 x 1/8 inch, HSS
-8	366-1057-00			1						KNOB, gray—VOLTS/DIV
				-						knob includes:
	213-0153-00			2						SETSCREW, 5-40 x 1/8 inch, HSS
	263-0009-00			1						SWITCH, wired—VOLTS/DIV
				-						switch includes:
-9	263-0510-00			1						SWITCH, unwired
				-						mounting hardware: (not included w/switch)
-10	337-1214-02			1						SHIELD
-11	210-0938-00			2						WASHER, flat, 0.109 ID x 0.250 inch OD
-12	384-0724-00			1						SHAFT-INDEX ASSEMBLY
				-						mounting hardware: (not included w/shaft-index assembly)
-13	210-0840-00			1						WASHER, flat, 0.390 ID x 3/16 inch OD
-14	210-0012-00			1						WASHER, lock, internal, 3/8 ID x 1/2 inch OD
-15	210-0413 00			1						NUT, hex., 3/8-32 x 1/2 inch
-16	131-0725-01			1						CONNECTOR, receptacle, w/capacitor
-17	105-0080-01			1						DRUM, attenuator, w/insert
				-						drum includes:
	213-0022-00			1						SETSCREW, 4-40 x 0.188 inch, HSS
-18	124-0230-00			2						ATTENUATOR STRIP, dummy
-19	426-0480-01			1						FRAME, attenuator
	131-0927-00			1						CONTACT PLATE (not shown)
				-						mounting hardware: (not included w/contact plate)
	210-0938-00			7						WASHER, flat, #2
	211-0169-00			4						SCREW, 2-56 x 1/8 inch, PHS
-20	670-1092-00			1						ASSEMBLY, circuit board-AC-DC-GND RELAY
				-						assembly includes:
	388-1309-00			1						BOARD, circuit
-21	136-0385-00			8						SOCKET, relay, 8 pin
				-						mounting hardware: (not included w/assembly)
-22	344-0143-00			2						CLIP
-23	211-0179-00			2						SCREW, 4-40 x 1/8 inch, PHS
	210-1002-00			2						WASHER, flat, 0.125 ID x 0.250 inch OD
	131-0886-00			1						ASSEMBLY, contact spring, rear
				-						assembly includes:
-24	214-1111-00			1						SPRING, flat

FIGURE 1 EXPLODED (cont)

Fig. & Index No.	Tektronix Part No.	Serial/Model No.		Q	Description					
		Eff	Disc							
				t						
				y	1	2	3	4	5	
1-25	131-0718-01			1	CONTACT, pin, electrical					
	358-0385-00			1	BUSHING, feedthru					
-26	346-0061-00			1	STRAP, connector					
	- - - - -			-	mounting hardware: (not included w/assembly)					
	210-0938-00			1	WASHER, flat, 0.109 ID x 0.250 inch OD					
-27	211-0069-00			1	SCREW, 2-56 x 1/8 inch, PHS					
	131-0706-00			1	ASSEMBLY, contact spring, front					
	- - - - -			-	assembly includes:					
-28	214-1111-00			1	SPRING, flat					
	131-0718-01			1	CONTACT, pin, electrical					
-29	358-0385-00			1	BUSHING, feedthru					
-30	346-0062-00			1	STRAP, connector					
	- - - - -			-	mounting hardware: (not included w/assembly)					
	210-0938-00			2	WASHER, flat, 0.109 ID x 0.250 inch OD					
-31	211-0169-00			1	SCREW, 2-56 x 1/8 inch, PHS					
-32	210-0259-00			1	LUG, solder, #2					
	- - - - -			-	mounting hardware : (not included w/lug)					
-33	211-0136-00			1	SCREW, 2-56 x 0.094 inch, PHS					
	131-0901-00			1	ASSEMBLY, standoff, pin					
	- - - - -			-	assembly included:					
-34	342-0012-00			1	INSULATOR, standoff					
-35	131-0885-00			1	TERMINAL, pin					
-36	131-0675-00			1	CONTACT, electrical					
	- - - - -			-	mounting hardware: (not included w/assembly)					
-37	211-0179-00			2	SCREW, 4-40 x 0.125 inch, PHS					
	210-1002-00			4	WASHER, flat, 0.125 ID x 0.250 inch OD					
-38	401-0051-00			1	BEARING, sleeve					
-39	337-1093-00			1	SHIELD, input					
	- - - - -			-	mounting hardware: (not included w/shield)					
-40	211-0136-00			4	SCREW, 2-56 x 0.094 inch, PHS					
-41	337-1094-00			1	SHIELD, output					
	- - - - -			-	mounting hardware: (not included w/shield)					
-42	211-0136-00			2	SCREW, 2-56 x 0.094 inch, PHS					
	- - - - -			-	mounting hardware: (not included w/switch)					
-43	211-0541-00			2	SCREW, 6-32 x 1/4 inch, 100° csk, FHS					
-44	211-0538-00			2	SCREW, 6-32 x 5/16 inch, 100° csk, FHS					
-45	214-1190-01			1	EXTENDER—RETRACTOR, knob					
	- - - - -			-	extender-retractor includes:					
	213-0076-00			1	SETSCREW, 2-56 x 0.125 inch, HSS					
	213-0239-00			1	SETSCREW, 3-48 x 0.062 inch, HSS					
-46	376-0093-00			1	COUPLING, half					
-47	214-0110-00			4	PIN, roll					
-48	384-0463-00			1	EXTENSION SHAFT, 4.29 inches long					
-49	384-0459-00			1	EXTENSION SHAFT, 3.937 inches long					
-50	- - - - -			1	RESISTOR, variable					
	- - - - -			-	mounting hardware: (not included w/resistor)					
-51	210-0471-00			1	NUT, hex., 1/4-32 x 19/32 inch					
-52	210-0046-00			1	WASHER, lock, 0.261 ID x 0.400 inch OD					
-53	358-0377-00	B010100	B010197	1	BUSHING, 0.275 inch long					
	358-0409-00	B010198		1	BUSHING					

FIGURE 1 EXPLODED (cont)

Fig. & Index No.	Tektronix Part No.	Serial/Model No.		Q † Y	Description
		Eff	Disc		
1-54	348-0157-00	B010100	B010249	2	SHIELDING GASKET
	348-0235-00	B010250		2	SHIELDING GASKET
-55	358-0378-00			1	BUSHING, sleeve
-56	358-0301-02			1	BUSHING, gray plastic, 0.188 inch ID
-57	386-1447-09			1	SUBPANEL, front
-58	366-1058-03			1	KNOB, latch
	- - - - -			-	mounting hardware: (not included w/knob)
-59	214-1095-00			1	PIN, spring
-60	105-0076-00			1	RELEASE BAR, latch
-61	214-1280-00			1	SPRING, helical
-62	337-1054-00			2	SHIELD, side
-63	426-0505-07			1	FRAME SECTION, top
	- - - - -			-	mounting hardware: (not included w/frame)
-64	213-0192-00			4	SCREW, thread forming, 6-32 x 0.625 inch Fil HS
	361-0326-00			1	SPACER, sleeve
-65	426-0499-07			1	FRAME SECTION, bottom
	- - - - -			-	mounting hardware: (not included w/frame)
-66	213-0192-00			4	SCREW, thread forming, 6-32 x 0.625 inch Fil HS
-67	214-1061-00			1	SPRING, flat sliding ground
-68	214-1054-00			1	SPRING, flat, latch detent
-69	105-0075-00			1	BOLT, latch, plastic
-70	670-1124-00			1	ASSEMBLY, circuit board—AC-DC-GND
	- - - - -			-	assembly includes:
-71	131-0589-00			7	TERMINAL, pin
	380-0154-00			1	HOUSING
	- - - - -			-	mounting hardware: (not included w/housing)
	213-0181-00			1	SCREW, thread forming, #2 x 0.375 inch, PHS
	- - - - -			-	mounting hardware: (not included w/assembly)
-72	211-0156-00			2	SCREW, 1-72 x 1/4 inch, FHS
-73	670-1125-00			1	ASSEMBLY, circuit board—POLARITY
	- - - - -			-	assembly includes:
-74	131-0589-00			6	TERMINAL, pin
	380-0153-00			1	HOUSING
	- - - - -			-	mounting hardware: (not included w/housing)
	213-0181-00			1	SCREW, thread forming, #2 x 0.375 inch, PHS
	- - - - -			-	mounting hardware: (not included w/assembly)
-75	211-0156-00			1	SCREW, 1-72 x 1/4 inch, FHS
-76	670-1126-00			1	ASSEMBLY, circuit board—BANDWIDTH
	- - - - -			-	assembly includes:
-77	131-0589-00			6	TERMINAL, pin
	380-0153-00			1	HOUSING
	- - - - -			-	mounting hardware: (not included w/housing)
	213-0181-00			1	SCREW, thread forming, #2 x 0.375 inch, PHS
	- - - - -			-	mounting hardware: (not included w/assembly)
-78	211-0156-00			1	SCREW, 1-72 x 1/4 inch, FHS
-79	386-1402-00			1	PANEL, rear

FIGURE 1 EXPLODED (cont)

Fig. & Index No.	Tektronix Part No.	Serial/Model No. Eff	No. Disc	Q					Description
				†	1	2	3	4	
1-80	670-1113-00	B010100	B019999	1					ASSEMBLY, circuit board—VERTICAL AMPLIFIER
	670-1113-01	B020000	B029999	1					ASSEMBLY, circuit board—VERTICAL AMPLIFIER
	670-1113-02	B030000	B039999	1					ASSEMBLY, circuit board—VERTICAL AMPLIFIER
	670-1113-03	B040000		1					ASSEMBLY, circuit board—VERTICAL AMPLIFIER
	- - - - -			-					assembly includes:
	388-1355-00			1					BOARD, circuit
	200-0945-00	XB020000		1					COVER HALF, transistor, temp stabilizer
	200-0945-01	XB020000		1					COVER HALF, transistor, temp stabilizer, threaded
	211-0001-00	XB020000		1					SCREW, 2-56 x 0.25 inch, PHS
-81	131-0157-00			1					CONNECTOR, terminal, standoff
-82	131-0589-00			27					TERMINAL, pin
-83	136-0252-01			106					SOCKET, pin connector
-84	214-0579-00			5					PIN, test point
-85	200-0945-03			1					COVER, half, transistor
-86	200-0945-02			1					COVER, half, transistor, threaded
-87	211-0001-00			1					SCREW, 2-56 x 1/4 inch, RHS
-88	- - - - -			2					RESISTOR, variable
	- - - - -			-					mounting hardware for each: (not included w/resistor)
-89	210-0046-00			1					WASHER, lock, internal, 0.261 ID x 0.400 inch OD
-90	210-0583-00			1					NUT, hex., 1/4-32 x 5/16 inch
-91	407-0644-00			1					BRACKET, component mounting
	670-1134-00			1					ASSEMBLY, circuit board-CAL-UNCAL
	- - - - -			-					assembly includes:
-92	388-1391-00			1					BOARD, circuit
-93	407-0663-00			1					BRACKET
	210-0656-00			3					EYELET (not shown)
-94	131-0604-00			2					CONTACT, spring
-95	351-0236-00			1					GUIDE, actuator
-96	214-1136-00			1					ACTUATOR
	- - - - -			-					mounting hardware: (not included w/assembly)
-97	211-0105-00			6					SCREW, 4-40 x 3/16 inch, 100° csk, FHS
-98	220-0547-01			6					NUT, 5/16-32 x 3/8 x 0.130 inch long
-99	211-0116-00			6					SCREW, sems, 4-40 x 5/16 inch, PHB
-100	131-0825-00			1					LINK, terminal connector
	- - - - -			-					mounting hardware: (not included w/link)
-101	211-0116-00			2					SCREW, sems, 4-40 x 5/16 inch, PHB
-102	210-1002-00			2					WASHER, flat, 0.125 ID x 0.250 inch OD
-103	210-0586-00			2					NUT, keps, 4-40 x 1/4 inch
-104	211-0169-00			2					SCREW, 2-56 x 0.125 inch, PHS
-105	210-1008-00			2					WASHER, flat, 0.090 ID x 0.188 inch OD
-106	376-0051-00			1					COUPLING
	- - - - -			-					coupling includes:
	354-0251-00			2					RING, coupling
	376-0049-00			1					COUPLING
	213-0048-00			4					SETSCREW, 4-40 x 1/8 inch, HSS

FIGURE 1 EXPLODED (cont)

Fig. & Index No.	Tektronix Part No.	Serial/Model No.		Q t y	1 2 3 4 5	Description
		Eff	Disc			
1-107	179-1427-00			1		WIRING HARNESS
	- - - - -			-		wiring harness includes:
-108	131-0621-00			17		CONNECTOR, terminal, straight
	131-0622-00			10		CONNECTOR, terminal, straight
-109	131-0707-00			17		CONNECTOR, terminal, straight
	131-0708-00			2		CONNECTOR, terminal, straight
-110	352-0164-00			2		HOLDER, terminal connector, straight, 6 wire
-111	352-0165-00			1		HOLDER, terminal connector, straight, 7 wire
-112	352-0197-00			4		HOLDER, terminal connector, straight, 1 wire
-113	352-0198-00			1		HOLDER, terminal connector, straight, 2 wire
-114	352-0199-00			1		HOLDER, terminal connector, straight, 3 wire
-115	352-0200-00			1		HOLDER, terminal connector, straight, 4 wire
-116	352-0203-00			2		HOLDER, terminal connector, straight, 7 wire

STANDARD ACCESSORIES

070-0980-00	2	INSTRUCTION, manual (not shown)
-------------	---	---------------------------------

MANUAL CHANGE INFORMATION

At Tektronix, we continually strive to keep up with latest electronic developments by adding circuit and component improvements to our instruments as soon as they are developed and tested.

Sometimes, due to printing and shipping requirements, we can't get these changes immediately into printed manuals. Hence, your manual may contain new change information on following pages.

A single change may affect several sections. Sections of the manual are often printed at different times, so some of the information on the change pages may already be in your manual. Since the change information sheets are carried in the manual until ALL changes are permanently entered, some duplication may occur. If no such change pages appear in this section, your manual is correct as printed.

TYPE 7A16

TENT SN B050267

ELECTRICAL PARTS LIST AND SCHEMATIC CORRECTION

VERTICAL AMPLIFIER Circuit Board Assembly

CHANGE TO:

R64	321-0076-00	60.4 Ω	1/8 W	MF	1%
R65	321-0024-00	17.4 Ω	1/8 W	MF	1%
R84	321-0076-00	60.4 Ω	1/8 W	MF	1%
R85	321-0024-00	17.4 Ω	1/8 W	MF	1%

M16 ,414/770

ELECTRICAL PARTS LIST CORRECTION

CHANGE TO:

	AC-DC-GND	Switch Circuit Board Assembly	
	670-1124-01	Complete Board	
S3 ¹⁴	670-1124-01	Pushbutton	AC-GND-DC
	POLARITY	Switch Circuit Board Assembly	
	670-1125-01	Complete Board	
S118 ¹⁴	670-1125-01	Pushbutton	INVERT
	BANDWIDTH	Switch Circuit Board Assembly	
	670-1126-01	Complete Board	
S75 ¹⁴	670-1126-01	Pushbutton.	BANDWIDTH